

Pioneer

Industrial DVD Player

DVD-V7400

Operating Instructions



IMPORTANT



The lightning flash with arrowhead symbol, within an equilateral triangle, is intended to alert the user to the presence of uninsulated "dangerous voltage" within the product's enclosure that may be of sufficient magnitude to constitute a risk of electric shock to persons.

CAUTION

RISK OF ELECTRIC SHOCK
DO NOT OPEN



The exclamation point within an equilateral triangle is intended to alert the user to the presence of important operating and maintenance (servicing) instructions in the literature accompanying the appliance.

IMPORTANT SAFETY INSTRUCTIONS

READ INSTRUCTIONS — All the safety and operating instructions should be read before the product is operated.

RETAIN INSTRUCTIONS — The safety and operating instructions should be retained for future reference.

HEED WARNINGS — All warnings on the product and in the operating instructions should be adhered to.

FOLLOW INSTRUCTIONS — All operating and use instructions should be followed.

CLEANING — Unplug this product from the wall outlet before cleaning. The product should be cleaned only with a polishing cloth or a soft dry cloth. Never clean with furniture wax, benzine, insecticides or other volatile liquids since they may corrode the cabinet.

ATTACHMENTS — Do not use attachments not recommended by the product manufacturer as they may cause hazards.

WATER AND MOISTURE — Do not use this product near water — for example, near a bathtub, wash bowl, kitchen sink, or laundry tub; in a wet basement; or near a swimming pool; and the like.

ACCESSORIES — Do not place this product on an unstable cart, stand, tripod, bracket, or table. The product may fall, causing serious injury to a child or adult, and serious damage to the product. Use only with a cart, stand, tripod, bracket, or table recommended by the manufacturer, or sold with the product. Any mounting of the product should follow the manufacturer's instructions, and should use a mounting accessory recommended by the manufacturer.

CART — A product and cart combination should be moved with care. Quick stops, excessive force, and uneven surfaces may cause the

GROUNDING OR POLARIZATION

- If this product is equipped with a polarized alternating current line plug (a plug having one blade wider than the other), it will fit into the outlet only one way. This is a safety feature. If you are unable to insert the plug fully into the outlet, try reversing the plug. If the plug should still fail to fit, contact your electrician to replace your obsolete outlet. Do not defeat the safety purpose of the polarized plug.
- If this product is equipped with a three-wire grounding type plug, a plug having a third (grounding) pin, it will only fit into a grounding type power outlet. This is a safety feature. If you are unable to insert the plug into the outlet, contact your electrician to replace your obsolete outlet. Do not defeat the safety purpose of the grounding type plug.

POWER-CORD PROTECTION — Power-supply cords should be routed so that they are not likely to be walked on or pinched by items placed upon or against them, paying particular attention to cords at plugs, convenience receptacles, and the point where they exit product and cart combination to overturn. from the product.

OUTDOOR ANTENNA GROUNDING — If an outside antenna or cable system is connected to the product, be sure the antenna or cable system is grounded so as to provide some protection against voltage surges and built-up static charges. Article 810 of the National Electrical Code, ANSI/NFPA 70, provides information with regard to proper grounding of the mast and supporting structure, grounding of the lead-in wire to an antenna discharge unit, size of grounding conductors, location of antenna-discharge unit, connection to grounding electrodes, and requirements for the grounding electrode. See Figure A.

LIGHTNING — For added protection for this product during a lightning storm, or when it is left unattended and unused for long periods of time, unplug it from the wall outlet and disconnect the antenna or cable system. This will prevent damage to the product due to lightning and power-line surges.

POWER LINES — An outside antenna system should not be located in the vicinity of overhead power lines or other electric light or power circuits, or where it can fall into such power lines or circuits. When installing an outside antenna system, extreme care should be taken to keep from touching such power lines or circuits as contact with them might be fatal.

OVERLOADING — Do not overload wall outlets, extension cords, or integral convenience receptacles as this can result in a risk of fire or electric shock.

OBJECT AND LIQUID ENTRY — Never push objects of any kind into this product through openings as they may touch dangerous voltage points or short-out parts that could result in a fire or electric shock. Never spill liquid of any kind on the product.

SERVICING — Do not attempt to service this product yourself as opening or removing covers may expose you to dangerous voltage or other hazards. Refer all servicing to qualified service personnel.

DAMAGE REQUIRING SERVICE — Unplug this product from the wall outlet and refer servicing to qualified service personnel under the following conditions:

- When the power-supply cord or plug is damaged.
- If liquid has been spilled, or objects have fallen into the product.
- If the product has been exposed to rain or water.
- If the product does not operate normally by following the operating instructions. Adjust only those controls that are covered by the operating instructions as an improper adjustment of other controls may result in damage and will often require extensive work by a qualified technician to restore the product to its normal operation.
- If the product has been dropped or damaged in any way.
- When the product exhibits a distinct change in performance — this indicates a need for service.

REPLACEMENT PARTS — When replacement parts are required, be sure the service technician has used replacement parts specified by the manufacturer or have the same characteristics as the original part. Unauthorized substitutions may result in fire, electric shock, or other hazards.

SAFETY CHECK — Upon completion of any service or repairs to this product, ask the service technician to perform safety checks to determine that the product is in proper operating condition.

WALL OR CEILING MOUNTING — The product should not be mounted to a wall or ceiling.

HEAT — The product should be situated away from heat sources such as radiators, heat registers, stoves, or other products (including amplifiers) that produce heat.



VENTILATION — Slots and openings in the cabinet are provided for ventilation and to ensure reliable operation of the product and to protect it from overheating, and these openings must not be blocked or covered. The openings should never be blocked by placing the product on a bed, sofa, rug, or other similar surface. This product should not be placed in a built-in installation such as a bookcase or rack unless proper ventilation is provided or the manufacturer's instructions have been adhered to.

POWER SOURCES — This product should be operated only from the type of power source indicated on the marking label. If you are not sure of the type of power supply to your home, consult your product dealer or local power company.

LOCATION — The appliance should be installed in a stable location.

NONUSE PERIODS — The power cord of the appliance should be unplugged from the outlet when left unused for a long period of time.

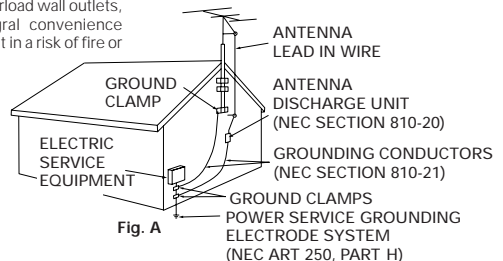

Fig. A

NEC — NATIONAL ELECTRICAL CODE

WARNING: TO PREVENT FIRE OR SHOCK HAZARD, DO NOT EXPOSE THIS APPLIANCE TO RAIN OR MOISTURE.

The stand-by/ ON switch is secondary connected and therefore, does not separate the unit from mains power in standby position.

CAUTION: This product satisfies FCC regulations when shielded cables and connectors are used to connect the unit to other equipment. To prevent electromagnetic interference with electric appliances such as radios and televisions, use shielded cables and connectors for connections.

This equipment has been tested and found to comply with the limits for a Class B digital device, pursuant to Part 15 of the FCC Rules. These limits are designed to provide reasonable protection against harmful interference in a residential installation. This equipment generates, uses, and can radiate radio frequency energy and, if not installed and used in accordance with the instructions, may cause harmful interference to radio communications. However, there is no guarantee that interference will not occur in a particular installation. If this equipment does cause harmful interference to radio or television reception, which can be determined by turning the equipment off and on, the user is encouraged to try to correct the interference by one or more of the following measures:

- Reorient or relocate the receiving antenna.
- Increase the separation between the equipment and receiver.
- Connect the equipment into an outlet on a circuit different from that to which the receiver is connected.
- Consult the dealer or an experienced radio/TV technician for help.

Information to User

Alteration or modifications carried out without appropriate authorization may invalidate the user's right to operate the equipment.

CAUTION

- Use of controls or adjustments or performance of procedures other than those specified herein may result in hazardous radiation exposure.
- The use of optical instruments with this product will increase eye hazard.

IMPORTANT NOTICE

THE SERIAL NUMBER FOR THIS EQUIPMENT IS LOCATED IN THE REAR.
PLEASE WRITE THIS SERIAL NUMBER ON YOUR ENCLOSED WARRANTY CARD AND KEEP IN A SECURE AREA. THIS IS FOR YOUR SECURITY.

CAUTION

CONSULT WITH THE COMPANY SALES REPRESENTATIVE.
"USE ONLY UL LIMITED AND CANADIAN CERTIFIED POWER SUPPLY CORD." AWG MINIMUM.
A POWER SUPPLY CORD TYPE SJT, 18 AWG MINIMUM, 3-WIRE GROUNDED TYPE SHALL BE USED WITH THIS EQUIPMENT.

[For Canadian model]

This Class B digital apparatus complies with Canadian ICES-003.

[Pour le modèle Canadien]

Cet appareil numérique de la Classe B est conforme à la norme NMB-003 du Canada.

FEDERAL COMMUNICATIONS COMMISSION DECLARATION OF CONFORMITY

This device complies with part of the FCC Rules. Operation is subject to the following two conditions: (1) This device may not cause harmful interference, and (2) this device must accept any interference received, including interference that may cause undesired operation.

Product Name: DVD player
Model Number: DVD-V7400
Product Category: Class B Personal Computers & Peripherals
Responsible Party Name: PIONEER ELECTRONICS SERVICE, INC.
Address: 1925 E. DOMINGUEZ ST. LONG BEACH, CA 90810 U.S.A.
Phone/FAX Number: (310) 952-2359 / (310) 952-2412

Note to CATV system installer

This reminder is provided to call CATV system installer's attention to Article 820-40 of the NEC that provides guidelines for proper grounding and, in particular, specifies that the cable grounding system of the building, as close to the point of cable entry as practical.

This product is equipped with technology for the protection of copyrights protected by U.S. patent claims and other intellectual property rights possessed by the Macrovision Corporation and other rights holders. Special permission from Macrovision Corporation is required for the use of this copyright-protection technology, and that permission has been received for home use and certain other limited applications. Reverse engineering and disassembly of this technology are prohibited.

Before using

Thank you for buying this Pioneer product.

Please read through these operating instructions before operating your DVD player. After you have finished reading the instructions, put them away in a safe place for future reference.

Check Accessories

Audio Cord	1	Laser Barcode Sheet	1
Video Cord	1	RF Adaptor Set Clamp	1
Remote Control	1	Screw	1
Batteries (AA/R6P)	2	Operating Instructions	1
		Warranty Card	1

Inserting batteries into the Remote Control

While pressing the back cover, pull out in the direction indicated by the arrow and insert AA size dry cell batteries.

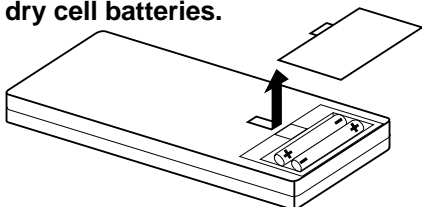

Note

- Do not mix old and new batteries
- Even batteries of the same type will differ in voltage so avoid mixing different type of batteries together
- When not using the remote control for a long period of time (over 1 month), remove the batteries to avoid possible damage from battery corrosion. If battery leakage occurs, wipe away the liquid from the battery compartment before inserting new batteries.

- Make sure to match the plus (+) and minus (-) polarity guides in the batteries with the marks inside the battery compartment. En

Component Features and Functions

1. High-Reliability, high-Endurance Player

This DVD player features a high-performance brushless spindle motor. The mechanical components are also sealed against heat and dust, giving this unit improved reliability.

2. NTSC/PAL Dual Playback

DVD discs in either the NTSC format or the PAL format are playable (See page 79)

3. Frame Search Function

Searching in units smaller than individual chapters is possible in this mode (see page 14).

While using frame segment playback, it is possible to play any point to any point in a video then continue the playback at the end (See page 55, 56).

- The frame search function cannot be used with a multi PGC disc (time is not displayed on the TV screen) or with a Video CD. Frame segment playback is possible with through RS-232C control with a DVD barcode or Barcode/Command stack.

4. High-Speed Search

With improved memory cache and a search algorithm, search speed is now at 1.3X reading speed (see page 13, 14).

5. Enhanced Special Playback

This player enables the DVD and Video CD playback speed to be changed in several ways. Slow Forward, Slow Reverse, Scan and Frame Forward/Reverse are easily selectable (see page 12, 14, 15).

- To perform Reverse Slow playback, select Frame from the REV STEP/REV PLAY page of the ADV.SETUP Menu. Slow play is only possible in the forward direction on a Video CD.

6. Mouse Control

Instead of the remote control, a PS/2* pointing device can be used to control the player if desired. A mouse allows selecting specific locations by the point-and-click method (see page 43).

* PS/2 is a registered trademark of IBM corporation

7. Weekly Timer/Power ON Start Function

The times for Power ON/OFF and for video playback of a disc can be set for each day within one day or within a week. Combined with the barcode/command stack, program playback is also possible. This player is limited to a maximum of 24 setting at one time (see page 44,52)

8. Barcode/Command Stack

When segment commands and barcodes are added to the player in advance, images can be switched and played back one after the other. This is very convenient for demonstrations, presentations, etc. The RS-232C connection allows uploading and downloading of the set content (see page 53).

- Upload/download is performed easily through a dedicated application.

9. Interface with External Signals (RS-232C, external option switch)

The device is fitted with an RS-232C connection so that commands support DVD, Video CD and CD technology. The control protocol is compatible with LD (Laser Disc) equipment with LD signals transferring easily.

In addition to the RS-232C connector, a terminal for the external option switch is provided. By simply connecting a switch to this terminal, operations through a DVD menu selection, barcode/command stack calls as well as commands with the remote control are possible.

- Consult the DVD-V7200 User's Manual for information regarding this terminal and RS-232C control commands (see your dealer for more information about the User's manual).

10. Video Blackboard Function

Graphics and characters input in advance at any desired positions on the DVD picture screen will appear during playback.

This function enables demonstrations and presentations to be performed more effectively (see page 71).

11. Laser Barcode Compatibility

The laser barcodes previously used with LD (Laser Disc) players supports most DVD applications. Existing barcode scanners and readers function properly with this player. (see page 59).

12. Video Text Retrieval (VTR)

Use the mouse to click on buttons displayed during DVD playback for display of text files corresponding to the selected button. This feature is only available on discs authored with Video Text Retrieval compatible discs (see page 77).

13. External Synchronizing Function

This terminal allows output of video signals linked to an external sync signal (see page 77).

Basic Operations

Remote Control Operations	10
Playing DVDs, CDs, and Video CDs.	10
Chapter (Track) Skip Forward/Skip Back	12
Stopping the Playback and Switching Power OFF.....	12
Searching For a Desired Scene (SEARCH)	13
Still Frame/Frame Advance/Frame Reverse	14
Slow Motion Play	15
Repeat Play	15
Program Play	16
Viewing Disc Information	18
Switching the Angle of the Image (Multi-Angle)	20
Switching the Subtitles During Playback	20
Switching the Audio During Playback	21
Switching the Stereo/Left/Right Audio	21
Index of the Graphical User Interface (GUI)	22
Operating the Initial Setup Menu	23
Selecting the Aspect Ratio	23
Changing Visual Setting	25
Setting the Language	27
Setting Viewing and Listening Restrictions (Parental Lock)	31
Making the Ordinary Settings	33
Setting the Digital Output	34
Setting to Optimize the Audio Quality	36
Returning to the Default Settings.....	38
Language Code List	38

Advanced Operations

Advanced Feature Operations	39
ADV. SETUP MENU Settings	41
Player Control Using a Mouse	43
Weekly Timer Function Operation/Display	44
Power on Start Function	51
Barcode/Command Stack Function	53
Barcode/Command Stack Setting	54
Grouping Some Barcode/Command Stacks	62
Using a Barcode/Command Stacks	69
Character Input/Output Drawing (DVD Video Blackboard)	71
Grouping Video Blackboards	75
Video Text Retrieval	77
External Synchronizing Function	77
How to Display Total Hours Played and Power ON Time	78
Connecting the Player	78
Using a Laser Barcode Scanner (Sold Separately)	84
Troubleshooting	85
Terms	86
Specifications	87

Precaution regarding use

Installation

- Install the player in a level and stable location. Do not place in shaky locations, or locations exposed to strong vibrations.
- Do not block the player's cooling vents. Avoid placing on long-pile carpets, etc.. Also do not wrap or cover with towels or cloths when in use. Such coverings can cause the player to overheat and may result in internal damage.
- Do not place objects on top of the player.
- Install in a location which is not exposed to heat sources. Avoid installing the player above an amplifier or other high-heat components. If installing the player in a component rack, select a rack with good ventilation and well below any amplifiers.
- If the player is installed in a rack, care must be taken to avoid internal temperature buildup. Position it so that the ventilation openings in the top and bottom of the player are not blocked. Install the player so that heat from below is limited and leave a gap of 4 inches or more on all sides and above so that air can flow around the device. A room temperature of no higher than 95°F is recommended. If installation is required in any other environment, ensure that the air temperature remains below 95°F when the unit is sufficiently warmed up. If necessary, make sure that forced air cooling (air conditioning) is available and adequate.
- When multiple players are connected in parallel, a power surge may pass through the units when external power is first turned ON. Please consult your Pioneer dealer regarding proper power switch ratings.
- Do not install the player in an enclosed rack. Internal temperature may build up resulting in internal damage.

Operating Environment

Operating environment temperature and humidity:
+5°C - +35°C (+41°F - +95°F) ; less than 85% RH (when cooling vents are unblocked)

■ Do Not Install in the Following Locations:

- exposed to direct sunlight or strong artificial light
- exposed to dust or smoke
- subject to vibration
- subject to strong electro-magnetic fields.
- near sources of heat
- exposed to high levels of electronic noise
- subject to electrostatic noise
- exposed to high humidity, or poorly ventilated locations
- enclosed racks

Moving the Player

When transporting this player to a new location, be sure to use the packaging provided and avoid subjecting the player to vibration, shock, or drops. During transport, protect the player from exposure to heat or water.

Before packaging the player, remove any disc loaded. Moving the player with a loaded disc may cause damage to the disc or to the player's internal parts.

Special Precautions!

Never attempt to move the player while a disc is playing. Discs rotate at very high speeds during play, and lifting or moving the player could cause damage to the disc.

Also, subjecting the player to strong impact or vibration when a disc is loaded may cause damage to the disc or player.

Verify that the player is stopped and the disc tray is empty before moving the unit.

Remove any discs before lifting the player.

This equipment is built using precision optical parts. Be sure to take care to control temperature and dust inside the room where it is installed.

Copyright

- Unauthorized public performance, broadcasting, or copying is a violation of applicable laws.
- This product incorporates copyright protection technology that is guarded by method claims of certain U.S. patents and other intellectual property rights owned by Macrovision Corporation and other rights owners. Use of this copyright protection technology must be authorized by Macrovision Corporation, and is intended for home and other limited viewing uses only unless otherwise authorized by Macrovision Corporation. Reverse engineering or disassembly is denied.

Handling the discs

■ Handling

- Never play clacked, scratched or warped disc. This may damage the player or cause it to malfunction.
- Do not damage or dirty the signal surface of the disc.
- Do not affix paper and seals to the disc.
- Too much glue will cause a malfunction. Many rental discs have labels affixed to them. Only use the disc after confirming that there is no glue.

■ Stacking

- Store the discs carefully. If you store discs at an angle or stacked on top of each other, discs may become warped even when in the dust jackets.
- Read the operating instructions included with the discs.

■ Cleaning

- **Fingerprints or smudges on the disc may affect the sound and picture quality. To remove grime, wipe gently from the inside towards the outer edge (do NOT wipe in a circular motion).**

- Avoid cleaning discs with record cleaning sprays, or static prevention sprays, etc. Also do not use volatile liquids such as benzine, or any thinners, etc.

- To clean your discs, use a soft clean cloth to wipe them. If necessary, moisten a soft cloth with diluted neutral detergent to remove heavy dirt or fingerprints.

■ Discs with special shapes

Discs with special shapes (heart shaped discs, hexagonal discs, etc.) cannot be played on this set. Attempting to do so may cause damage to the player.

Lens Cleaning

The player's pickup lens remains clean during normal use but if it malfunctions due to soiling, contact your nearest Pioneer Authorized Service Center. Lens cleaners are commercially available, however, special care should be exercised in their use since some may cause damage to the lens.

Condensation

If a player is brought from cool surroundings into a warm room or the temperature changes suddenly, moisture may gather inside of the unit. When this happens, the player's performance becomes affected.

To prevent this, let the player stand in its new surroundings for an hour or more before switching it on or make raise the room temperature gradually.

Condensation may also form during the summer if the player is placed within the breeze from an air conditioner. In such cases, move the unit to another location.

Disc types compatible with this unit







- The marks shown below are found on disc labels or on disc jackets.
- The DVD-V7400 plays discs bearing the marks below without needing an adaptor.
- This player can play discs recorded in either PAL or NTSC format. Use discs marked with "NTSC" or "PAL" on the jacket or sleeve.

Types of playable discs and their marks	Diameter/Playable sides
	DVD VIDEO
	12 cm (5")/single sided 1 layer
	12 cm (5")/double sided 1 layer
	12 cm (5")/double sided 2 layer
	DVD VIDEO
	8 cm (3")/single sided 1 layer
	8 cm (3")/single sided 2 layer
	8 cm (3")/double sided 1 layer
	VIDEO CD
	12 cm (5")/single sided
	VIDEO CD single
	8 cm (3")/single sided
	CD
	12 cm (5")/single sided
	CD single
	8 cm (3")/single sided

- The following discs cannot be played on this player: DVD audio, DVD-ROM, CD-ROM, DVD with region codes other than 1 or ALL
- Do not use an 8cm (3") adaptor with this player

■ DVD identification markings

The following symbols are added to DVD discs and packaging to indicate the type of video or audio and the functions supported by the disc:

Mark	Meaning
	Number of the audio track
	Number assigned to the subtitle language
	Number of angles
	Available picture aspect ratios
 	The region number where playback is possible This player can play back discs which include region number "1" and discs on which "ALL" is inscribed

■ Disc operation methods

The DVD operation method depends on the intention of the disc creator, there are some discs that prohibit specific operations. Depending upon the disc, the operation method differs thus specific operations may not be possible. If a specific operation has been prohibited, the "Disc prohibition" mark is displayed on the screen. If a disc is authored to allow interactive operations through the menu and during playback, some operations such as Repeat and Program may not be possible. In this case, the "Prohibition due to the Player" mark is displayed on the screen.

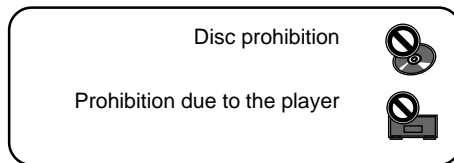

Names and Functions

Remote control unit

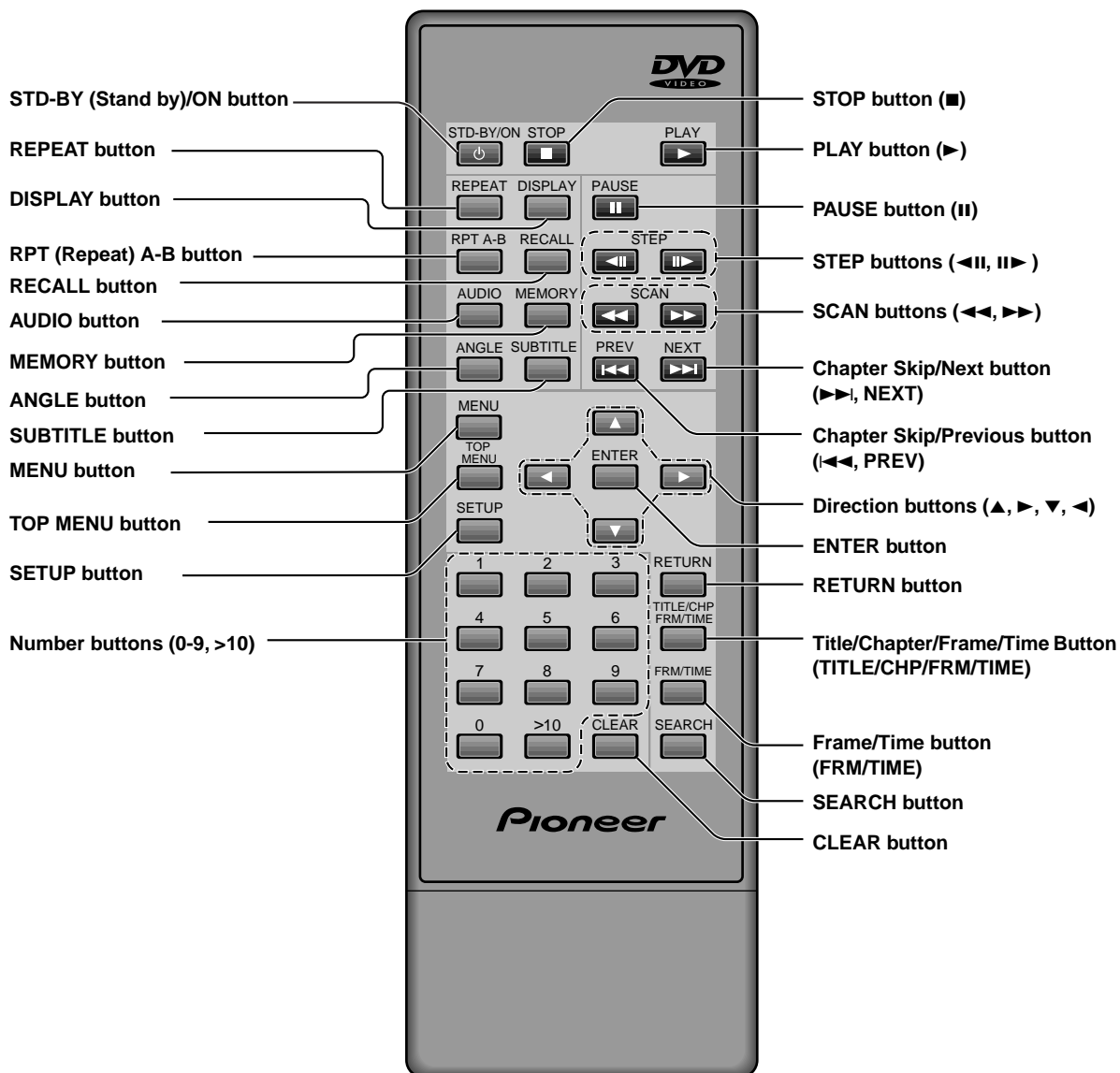

* When using a wired remote control (sold separately: CU-V155), some key labels need updates. Refer to the Pioneer Web page (listed on back cover) for details.

■ Front panel

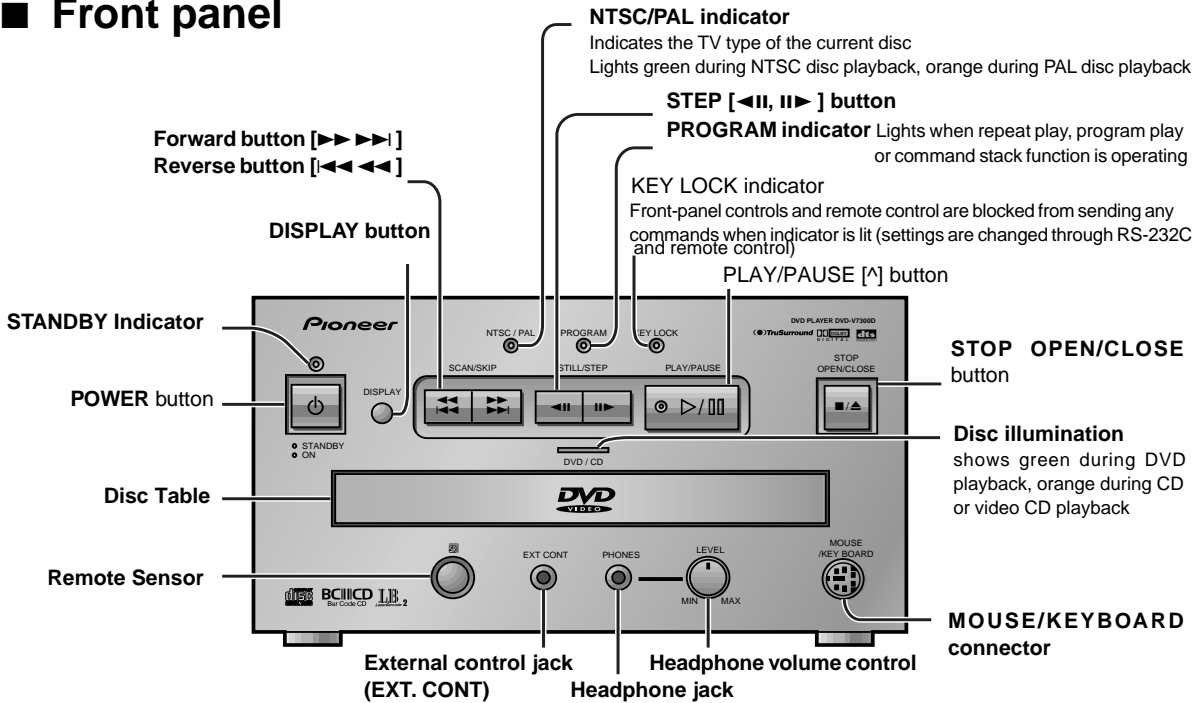

■ Rear panel

Your amp	Settings
Regular AV amp	Select [Dolby Digital ▶ PCM] from the SETUP MENU. (See page 34)
Dolby Digital compatible amp	Select [Dolby Digital] from the SETUP MENU. (See page 34)

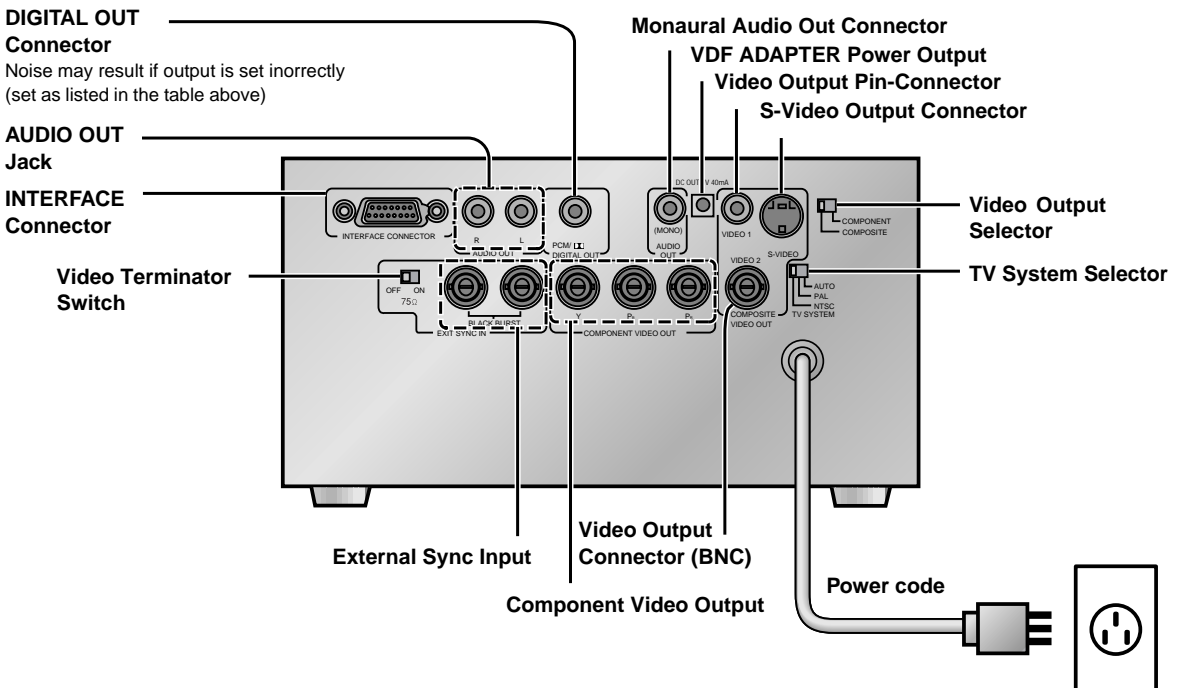

Basic Operations

Remote Control Operations

Wireless Remote Operation

When operating the remote control, point it at the sensor located on the player's front panel. The remote control can be used up to 23 feet (7m) from the player, within a 30° angle to each side of the sensor.

- Exposing the remote sensor to direct sunlight or strong light may cause faulty operation

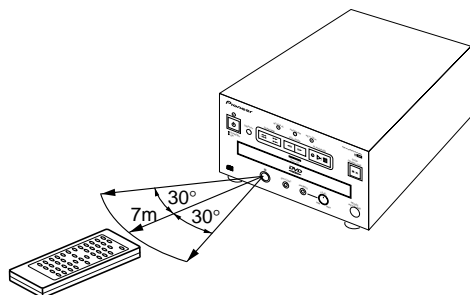

Wired Operation

Wired operation is possible with a different remote control (sold separately). Connect the remote control cord to the external jack (EXT.CONT) on the player's front panel.

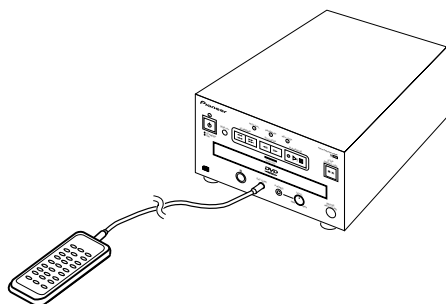

Playing DVDs, CDs, and Video CDs

DVD Video CD CD

1 Press STD-BY/ON

The player's standby indicator changes from orange (Stand By) to green (Power ON).

2 Press STOP OPEN/CLOSE

The disc table slides out.

3 Load a disc

Load a disc with the label side facing up, using the disc table guide to align the disc.

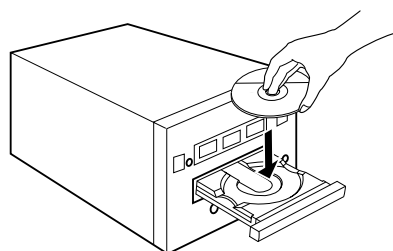

4 Press PLAY

- The disc table closes and playback begins.
- Press  on the front of the player.
- If a menu is available on the disc, it is displayed. (refer to the next page for menu information)

Note:

- DVD discs must have a region code that matches the code currently set on the player (refer to the "Terms" section on page 86). (This unit's region code is "1".)
- During operation, the following marks may appear on the TV/monitor screen



: Appears when the player is unable to perform the selected function



: Appears when the disc is unable to perform the selected function

DVD Video CD**When the Menu Screen is Displayed**

DVDs and Video CDs usually feature selection menus.

This player supports menus for choosing available titles and music from the disc.

■During DVD Playback

Press to scroll to an

item and press (Example)

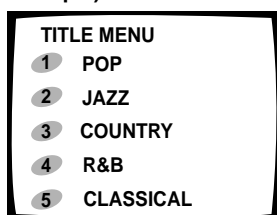
**■During Video CD playback**

Select with the number buttons.

- When the menu screen consists of two pages or more, press

to turn the pages.

Example)

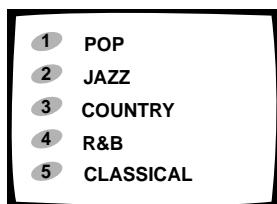
**■Turning the menu screen display off/on**

The way to display the menu screen differs depending on the disc, but menu screen is returned with DVD by pressing or during playback, and with Video CD, by pressing during PBC playback.

- Regarding operations on the menu screen, refer to the information included with the disc.

DVD Video CD**Returning to Menu Display During Playback****■During DVD Playback**

1 Press

- Press again for a list of titles
- Operate according to disc menus

■During Video CD Playback

1 Press

Pressing during PBC playback displays the menu.

Because the player's operation method and functions depend on the PBC, playback will differ according to the disc. For details, please refer to the disc's instruction manual.

Note

- When using a menu for Video CD playback; the repeat Play and Track/Time Search functions are disabled.
- Menu details differ depending on the disc. Play a disc by making menu selections using , and the number buttons.
- You can also play Video CDs without calling up a menu by pressing or a number button when the player is stopped. To play from track 1, simply press .

Chapter (Track) Skip Forward/Skip Back

DVD Video CD CD

Skipping Forward to the Next Chapter (Track)

Press ^{NEXT} 

- Press to skip forward to the next chapter or track
-  on the front panel has the same function

DVD Video CD CD

Skipping Back to the Previous Chapter (Track)



Press ^{PREV} 

- Press once to skip back to the start of the chapter (track) currently playing
- Press again to skip back to the start of the previous chapter (track)
-  on the front panel has the same function

DVD Video CD CD

Fast Forward

Press and hold ^{SCAN} 



- Release  when you reach the desired location. Normal playback resumes.
 -  on the front panel has the same function.
 - When the "Scan" indicator on the screen changes from flashing to lit, fast forward continues even if the button is released
- When the destination has been reached, press the button,

^{SCAN} 

DVD Video CD CD

Fast Reverse



Press and hold ^{SCAN} 

- Release  when you reach the desired location. Normal playback resumes.
 -  on the front panel has the same function
 - When the "Scan" indicator on the screen changes from flashing to lit, fast reverse continues even if the button is released
- When the desired location has been reached, press the button,

^{SCAN} 

Stopping Playback and Switching Power OFF

DVD Video CD CD

- 1** Press ^{STOP} 
- On the front panel, press 
 - Playback stops

- 2** Press ^{STOP OPEN/CLOSE} 
- The disc table slides out.

- 3** Remove the disc

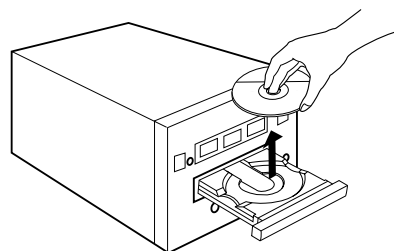

- 4** Press ^{STD-BY/ON} 
- The disc table goes back in, power switches OFF, and the STANDBY indicator changes from green to orange.

Searching For a Desired Scene (SEARCH)

DVD



Direct Search with Title Numbers During Playback

1 Press  during playback

Title : 1

2 Selecting Title numbers using the number buttons

Title : 3

- When selecting Title 3, simply press 
- When selecting Title number 10, press  → 

3 Press 

- Pressing  is also an option

DVD

Direct Search with the Title Numbers in the Stop Mode

Pressing number buttons to select the Title when the unit is in the Stop mode, causes playback to start at the beginning of the selected Title.

To select Title 3

Press 

To select title number 10

Press  →  → 

DVD Video CD CD

Searching by Chapter/Track Number

■ Using the TITLE/CHP FRM/TIME button

1 Press  repeatedly to choose an option

DVD: Chapter numbers flash on screen when pressed twice

Video CD/CD: Track numbers flash on screen when pressed once

2 Select chapter/track numbers using the number buttons





Example 1: To select chapter/track number 31

Press  → 

Example 2: To select chapter/track number 117

Press  →  → 

3 Press 

- Playback of the selected chapter/track begins 
- Pressing  or  is also available except 

DVD Video CD CD

Chapter/Track Search

Press the number buttons to select a Chapter/Track while a disc is playing and playback starts from the beginning of the Chapter/Track.

Example 1: To select chapter/track number 3

Press 

Example 2: To select chapter/track number 17

Press  →  → 

Note

- If  appears when the numbers are entered, this search feature is unavailable on this disc.

Searching for a Desired Scene (SEARCH)

DVD Video CD

Searching by Time/Frame Number (Time Search/Frame Search)

- 1 Press  to select the frame input mode or the time input mode

• With Video CD, only time search is available





- 2 Select time/frame numbers with the number buttons

Example : To select 21 minutes 43 seconds



• With DVD, time/frame searches must be within a single Title, rather than overlapping titles.

- 3 Press 

• Pressing  or  is also available except 

- Playback starts from the selected elapsed play time.
- For frame searching, the Still Frame mode is set at a particular frame (frame accuracy may vary with they type of disc in use).



Example:

Discs recorded with a slide show or a DVD movie are set to 24 frame per second.

- Time Searches/Frame Searches are unavailable for discs that do not provide playback time data within a Title.

(press  to check for Time codes, see page 19)

Point

- To cancel the flashing Title, Chapter/Track/Time display, press the  button twice.
- Making selections from a menu is possible for some titles. Simply press  to display the menu screen then choose an item from the list.

Note

- With DVD, Time Searches are unavailable on certain disc Titles, when the  mark is displayed.
- When performing DVD or Video CD Time Searches, the playback may start from a slightly different time.
- On DVD discs, a Time Search is unavailable when the unit is in the Stop mode.
- Searches using the above method are ignored during PBC playback from Video CDs.
- An error may occur when a Frame Search is issued several frames before or after Title and Chapter breaks; this occurs because of the way in which a DVD disc is produced.

Still Frame/Frame Advance/Frame Reverse

DVD Video CD

Frame Advance/Frame Reverse (back the picture up by 1 frame)

- 1 Press  

 : The picture advances by one frame each time the button is pressed.

 : The effect differs according to the settings (DVD). (see below)

REV STEP/PLAY in ADV. SETUP is by Frame or VOB (see page 42)

Frame : The picture reverses by one frame each

time the  button is pressed

VOBU* : The picture reverses in VOB

each time the  button is pressed

- The ability to advance or reverse the picture by one frame depends upon the type of data recorded on the disc such as a DVD movie in 24 frames per second.
- If Still Images appear shaky when playing back DVD stop-motion frames, set the Still Picture to "Field" (see page 25). Vertical resolution quality is reduced by half but blurriness is eliminated from the picture.

- If VOB is selected, each time the  is pressed, then playback is reversed by 0.4 seconds to 1 second.

* **VOBU = Video Object Unit:**



In DVD-VIDEO, it is the smallest unit that forms a stream. A VOB is from 0.4 seconds to 1 second in duration.

DVD Video CD

Still Picture

- 1 Press 

Note

- There is no sound when viewing Still frames or when advancing one frame at a time.
- Pause may not be possible with certain discs. In this case, the  mark is displayed.
- When pressing , playback is halted and background color (default color is turquoise) appears on the screen.

Slow Motion Play



DVD Video CD

Forward Slow Playback

Press and hold  during playback

To change the speed of slow playback

During slow playback, the speed can be adjusted to

four separate settings by pressing  and 

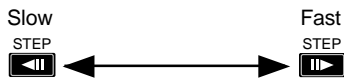

For DVD STEP1 ($1/30$) - $1/16$ - $1/8$ - $1/4$ - $1/2$ - $1/1$

For Video CD $1/16$ - $1/8$ - $1/4$ - $1/2$
(units: seconds)

DVD

Reverse Slow Motion

Press and hold  during playback

To change the Slow Motion speed

The action differs depending on the REV STEP/REV PLAY setting on the ADV SETUP menu (page 42).



For frame: $1/1$ - $1/2$ - $1/4$ - $1/8$ - $1/16$ - STEP1 ($1/30$)
(units: seconds)

For VOBU*: Reverse slow playback in VOBU units

* VOBU = Video Object Unit:

In DVD-VIDEO, it is the smallest unit that forms a stream and is from 0.4 seconds to 1 second in duration.

DVD Video CD

Return to Normal Playback

Press 

Note

- No sound will be heard during Slow Motion

Repeat Play

DVD Video CD CD

Repeat Play of a Chapter/Track

1 During playback of the chapter or track you wish to repeat, press  so that Repeat Chapter is displayed

- With CDs and Video CDs, Repeat Track is displayed.

DVD Video CD CD

Repeat Play of a Title

1 During playback of the Title to be repeated, press  so that Repeat Title is displayed.

- With DVD discs, the title continues playing until the end, then playback starts once more from the beginning of that title.
- CDs and Video CDs have a single Title per disc thus the entire disc is repeated.

DVD

Repeat Play of All Titles

1 During playback, press  so that Repeat All is displayed

- This operation is effective only when the menu's TITLE PLAY MODE is set to All (see page 41).
- When playback has continued until the end of the final Title, playback begins again from Title 1.

DVD Video CD CD

Repeat Play of a Specified Section

1 Press  at the beginning and end of the section you want to repeat

DVD Video CD CD

Return to a Specified Location

1 Press  at the desired location



2 To return, press 

- Press  to clear a specified location

Tips

- To cancel Repeat Play, press . The Repeat Play mode is cancelled, playback continues normally.

Note

- With some DVD discs, there may be times when Repeat playback is not possible because of the Title. In this case, the  mark appears on the screen.
- With Video CDs, Repeat is unavailable during playback when the menu is displayed (PBC playback). To perform a Repeat of the last segment, start playback without displaying a menu. (see pg 11) press 
- PROGRAM indicator on the main unit lights during Repeat

Program Play

The contents of one disc can be arranged in order. Programming is possible up to a maximum of 24 steps.

DVD

1 Press **MEMORY** three times

PROGRAM is displayed on the television screen

2 Press **ENTER**

The Program screen is displayed

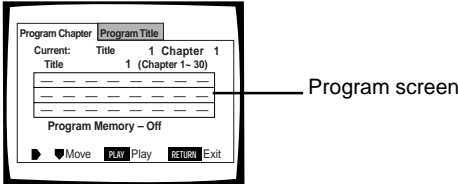

Program screen

3 With **▲ ▼ ◀ ▶**, select the mode

Program Chapter:
(when programming Chapters)
Program Title:
(when programming Titles)

4 With **▲ ▼ ◀ ▶**, move the cursor to the Program input screen

5 With the number buttons, select the Chapters and Titles to be played back in any sequence

Example) To program titles or chapters in the sequence

9, 7, 18, press **9**, **7**, **>10**, **1**, **8**

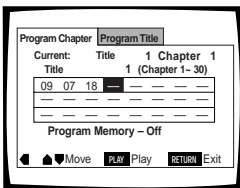

■ To input Chapters and Titles during playback

Press **ENTER**

6 With **▲ ▼ ◀ ▶** buttons, move the cursor to the Chapter or Title where playback needs to start

7 Press **PLAY**

Playback starts in the programmed sequence

- When **RETURN** is pressed, the programming ends without playing the sequence.

Note

- If the current Title number (upper display side) is different from the Title number (lower side), inputting Chapters using the **ENTER** button is unavailable. Use numeric buttons to input Chapters numbers.
- For DVD discs, Program Play may be unavailable depending upon the disc. Then or appears on the screen.
- To program Chapters, the Chapters must be within the same Title.
- When the view is changing from Chapter to Chapter during Program play, the display of the next chapter appears on the screen although it may not be the next programmed Chapter. This is a standard feature of the player.

Video CD CD

1 Press **MEMORY** three times

PROGRAM is displayed on the display

2 Press **ENTER**

The Program screen is displayed

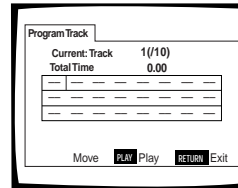

3 With the number buttons, Tracks may be played back in any sequence

Example) To program tracks in the sequence 9, 7, 18,

press **9**, **7**, **>10**, **1**, **8**

4 With **▲ ▼ ◀ ▶** buttons, move the cursor to the required track

5 Press **PLAY**

Playback starts in the programmed sequence

- When **RETURN** is pressed, the programming ends without playing any additional sequences.

Note

- During Video CD PBC playback, programmed playback is unavailable.

DVD Video CD CD

To Stop Program Play

1 Press  during play

Normal playback starts from the Chapter/Track playing currently.

Notes

- Opening the disc table completely erases the program.
To save a program recorded with this player and a DVD disc, refer to [page 18](#).
- Press  while the player is stopped to erase the program.

DVD Video CD CD

Programming a Pause

1 Press  in the Program input screen

"II" is displayed and a pause is added to the program.

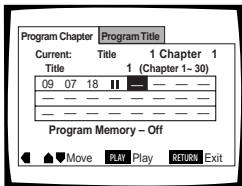

- When a pause is added, playback pauses at the start of the next programmed sequence (Title, Chapter/Track).
Then press the  button to continue playback.

Notes

- It is not possible to program a Pause at the beginning and at the end of a program.
- A Pause must have a programmed sequence before and after the command.

DVD Video CD CD

Checking a Program

1 Press  three times

"PROGRAM" is displayed on the TV screen

2 Press 

With a DVD, press   and select "Program Chapter" or "Program Title".

- To start program playback, press  and to end a program, press .

DVD Video CD CD

Erasing the Contents of a Program One by One

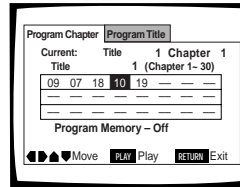

1 With     buttons, select the numbers to be erased.

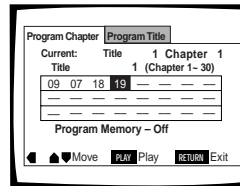

2 Press 

The designated numbers are erased and the next programmed sequences are moved forward.



- To start program playback, press . To end playback, press .

DVD Video CD CD

Adding a Program

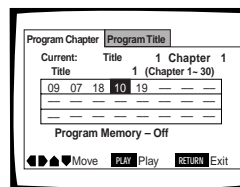

1 With     buttons, select a place for the insertion.

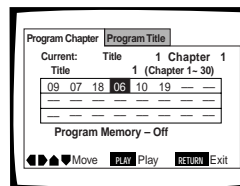

2 Press the number button

The designated number moves back and a new number is inserted.



- To start program playback, move the cursor to the number where playback needs to begin and press . To end a program, press .
- When all of the program (up to 24 steps) has been input, erase using the  button before adding steps.

Program Play



DVD

Recording the Program (Program Memory)

This player can record DVD programs up to a maximum of 24 discs, even if the disc is removed. When a program is recorded, program playback starts when next that same disc is played. When the recorded discs exceeds 24, the programs are automatically erased starting with the oldest discs.

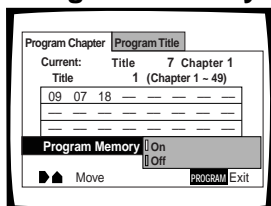
1 With    , select **[ON]** in “Program Memory” and press .



- To start program playback, move the cursor to the number to be played back first and press the button, . To end a program, press .

DVD

Erasing the Program of the Disc Which is In Use

1 Press   to select **[OFF]** in **[Program Memory]** then .

- However, the numbers remain as they were on the Program input screen while the program for the disc is erased.

Viewing disc information

Viewing Disc Information While Stopped

1 Press  while stopped

The disc information screen is displayed.

DVD

The Titles and the Chapter numbers within the respective Titles are displayed.

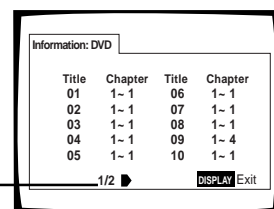

1/2 shows that there are two pages of information and that this screen is the first of those pages.

When there are two or more pages of disc information, the next screen is displayed when the arrow button  (right direction) is pressed.

Video CD CD

The tracks and the respective track times are displayed.

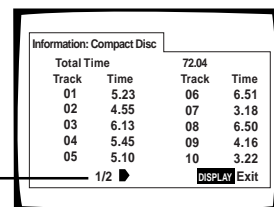

1/2 shows that there are two pages of information and that this screen is the first of those pages.

When there are two or more pages of disc information, the next screen is displayed when the cursor button  (right direction) is pressed.

To switch off the disc information

Press  again to hide the disc information screen.

Viewing Disc Information During Playback

1 Press  repeatedly during play

When pressed, the following kind of disc information is displayed in the upper part of the screen.

DVD

Pressing **once** reveals the present frame information.

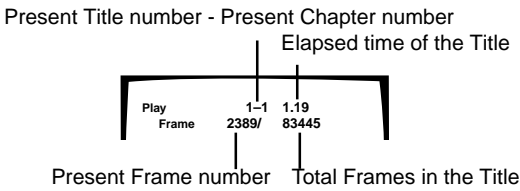

Pressing **twice** reveals the present Title information.

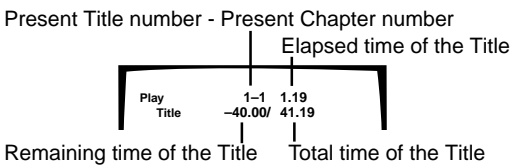

Pressing **three** times reveals the present Chapter information.

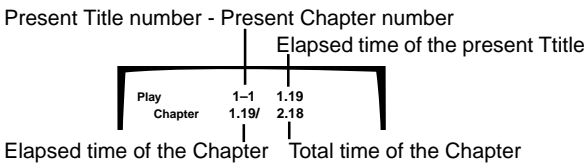

Pressing **four** times reveals additional chapter information.

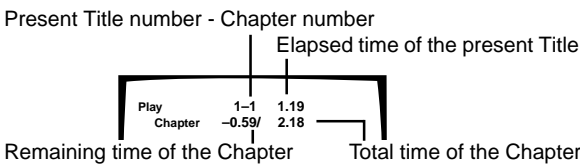

Pressing **five** times reveals the transfer rate* level meter.

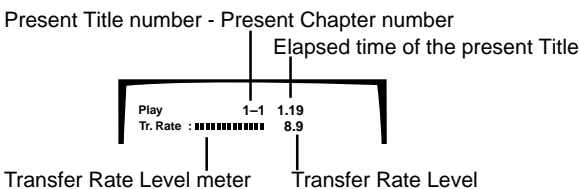

* TRL is the value that shows the amount of picture data recorded on the DVD. The higher the Transfer Rate level, the greater amount of information can be processed but the picture quality may suffer.

Pressing **six** times hides the display screen.

Video CD

Pressing **once** reveals the information for the currently playing Video CD.

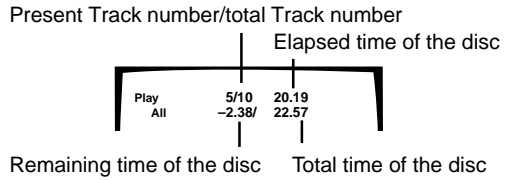

Pressing **twice** reveals the present track information.

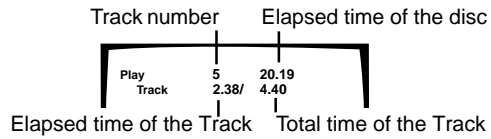

Pressing **three** times reveals additional track information.

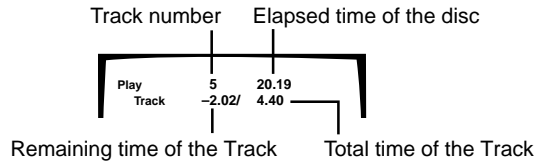

Pressing **four** times hides the display screen.

- Disc information is unavailable during PBC playback of a Video CD.

CD

Pressing **once** reveals the present track information.

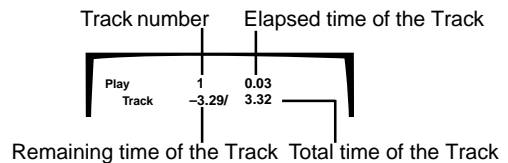

Pressing **twice** reveals the present information for the CD.

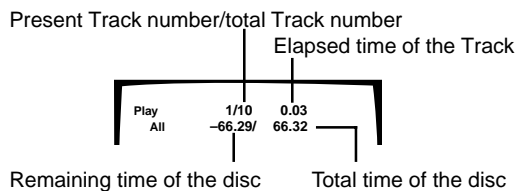

Pressing **three** times hides the display screen.

Switching the Angle of the Image (Multi-Angle)

DVD

DVDs featuring pictures shot from different angles provide choices of various viewing perspectives.

These discs have a  mark printed on the disc jacket.



1 If the  mark is displayed during playback, press  ANGLE

2 Press  ANGLE again to select the desired angle

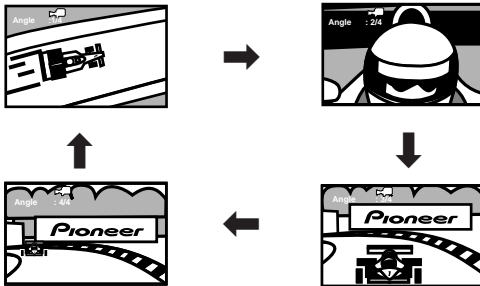
The angle changes each time  ANGLE is pressed



Note

-  is displayed on the screen when a sequence has multiple angles available.
- When the angle is switched during a pause, the pause is cleared.
- On some DVDs, the angle can be switched from the disc menu screen.
- To hide the angle icon , set the Angle Indicator to OFF in the initial setup menu (page 26).

Switching Subtitles During DVD Disc Playback

DVD

When a DVD disc with multiple languages or subtitles is played, the displayed subtitles may be changed during playback.

1 Press  SUBTITLE during playback of the DVD



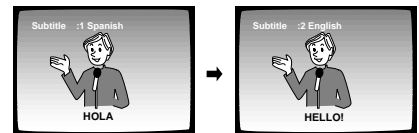

The currently selected subtitles are displayed

2 Press the  SUBTITLE button again

The subtitle display changes each time  SUBTITLE is pressed.



Note

- To cancel the subtitles, press  SUBTITLE then press  CLEAR, or press  SUBTITLE and select [OFF].
- Some DVDs allow subtitles to be switched from the disc menu screen. If so, press the  MENU button and make a selection (page 11).
- The subtitle language here is temporary thus when playback stops, the subtitle language returns to the selection set in the initial Setup menu (Subtitle Language, (page 27)).

Switching the Audio During Playback

DVD

While a DVD with multiple audio streams is playing, the audio can be changed

1 Press **AUDIO** while the DVD plays

The currently selected audio is displayed.

2 Press **AUDIO** again

The audio changes each time **AUDIO** is pressed.

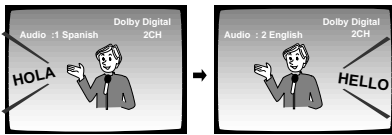

Note

- The audio stream may also be switched from the menu screen. To switch the audio, press **MENU** and make a selection from the menu (page 11).
- This audio language selection is temporary. When playback stops, the audio language returns to the selection set in the initial Setup menu (Audio Language, page 27).
- The picture may momentarily stop when the audio changes depending upon how the disc was produced.

Switching the Stereo/Left/Right Audio

Video CD CD

The audio type on Video CDs and CDs can be switched.

1 Press **AUDIO** during playback of a CD or Video CD

Each time the button is pressed, the audio cycles through Stereo, 1/L (left) and 2/R (right).

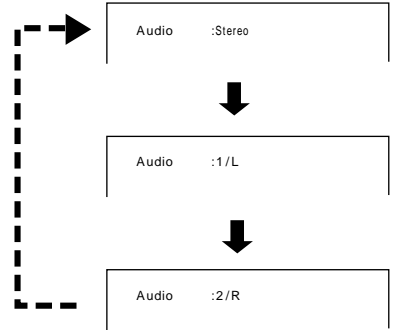

Note

- With Karaoke, etc., cycle to the type of audio marked on the disc jacket to set the stream to accompaniment music only.

Index of the Graphical User Interface (GUI)

On this player, various settings can be selected while watching menu screens.

Here we will explain how to access menu screens. Because menu screen access differs according to the type of disc being used, or the playback mode (stop mode etc.), refer to the following menu map when accessing.

Audio1	2	Video	Language	General
Dolby Digital Out	<input checked="" type="checkbox"/>	Dolby Digital	page 34
		Dolby Digital	▶ PCM	
DTS Out	<input checked="" type="checkbox"/>	Off	page 34
		DTS		
96kHz PCM Out	<input checked="" type="checkbox"/>	96kHz	▶ 48kHz
		96kHz		page 35
MPEG Out	<input checked="" type="checkbox"/>	MPEG	page 35
		MPEG	▶ PCM	
Digital Out	<input checked="" type="checkbox"/>	On	page 36
		Off		

1	Audio2	Video	Language	General
Virtual Surround	<input checked="" type="checkbox"/>	Off	page 36
		VDD/Tru Surround		
Audio DRC	<input checked="" type="checkbox"/>	Large	page 37
		Medium		
		Small		
		Off		

Audio1	2	Video	Language	General
TV Screen	<input checked="" type="checkbox"/>	4:3 (Letter Box)	page 23
		4:3 (Pan & Scan)		
		16:9 (Wide)		
Still Picture	<input checked="" type="checkbox"/>	Field	page 25
		Frame		
		Auto		
On Screen Display	<input checked="" type="checkbox"/>	On	page 25
		Off		
OSD Position	<input checked="" type="checkbox"/>	Wide	page 26
		Normal		
Angle Indicator	<input checked="" type="checkbox"/>	On	page 26
		Off		

Audio1	2	Video	Language	General
Audio Language	<input checked="" type="checkbox"/>	English	page 27
		Other		
Subtitle Language	<input checked="" type="checkbox"/>	English	page 27
		Other		
Auto Language	<input checked="" type="checkbox"/>	On	page 28
		Off		
DVD Language	<input checked="" type="checkbox"/>	w/ Subtitle Language	page 29
		English		
		Other		
Subtitle Display	<input checked="" type="checkbox"/>	On	page 29
		Off		
		Assist Subtitle		
Subtitle Off	<input checked="" type="checkbox"/>	With Audio	page 30
		Selected Subtitle		

Audio1	2	Video	Language	General
Parental Lock	<input checked="" type="checkbox"/>	Level Change	page 31
		Password Change		
Screen Saver	<input checked="" type="checkbox"/>	Off	page 33
		Black		
		Background Color		
Background Color	<input checked="" type="checkbox"/>		page 33

indicates the setting when shipped

Operating the Initial Setup Menu

DVD Video CD CD

The basic operating method for the initial Setup menu and the locations of the appropriate buttons are explained below.

■ Displaying the initial Setup menu

1 Press  STD-BY/ON

When the power has been turned on, proceed to **2**.

2 Press  SETUP

The initial setup menu is displayed.

Example:

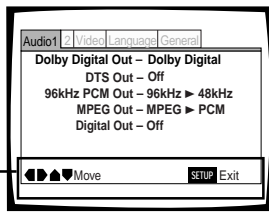

buttons for making menu selections

■ Settings that function immediately after changing depend on the type of disc

Depending on the type of disc, (DVD, Video CD or CD) some settings work immediately after changing. This player confirms changes by indicator color (light to the left of the selected setting). See the following table.

Color of the indicator	Type of disc
Blue	DVD only
Yellow	DVD/Video CD only
Green	Not affected by the type of disc

■ Settings that are locked during playback

Settings that are unavailable for change during playback appear gray.

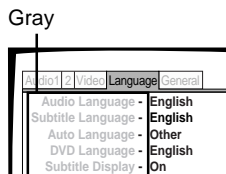

Selecting the Aspect Ratio

DVD

Set the Aspect Ratio to match the display device connected to the player. This setting is unnecessary when connecting to a wide-screen television.

Most DVD movies support wide-screen devices with the screen size ratio (usually called the aspect ratio) set to 16:9 (horizontal:vertical). Consequently, if a DVD is viewed on a television of the conventional size, the 4:3 aspect ratio increases the height of the image. Set the aspect ratio to 4:3 to eliminate the distortion. The aspect ratio is locked during disc playback.

1 Press  SETUP

The initial setup menu is displayed.

2 Select [Video]

3 Select [TV Screen]

4 Press the arrow button  (right direction)

5 Select the preferred item

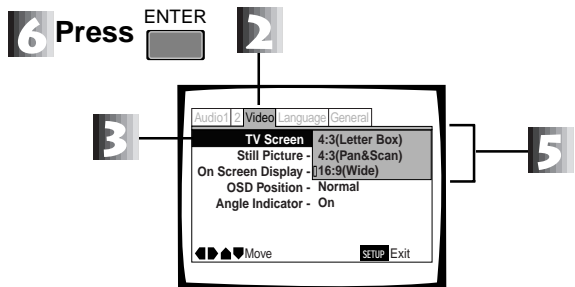

4:3 (Letter Box):

Select when a television of the conventional size is connected with the picture in the letter box format (see the following page).

4:3 (Pan & Scan):

Select when a television of the conventional size is connected with the picture sides cut away (see the following page).

16:9 (Wide):

Select when a wide-screen device (16:9) is connected (default setting when shipped).

7 Press  SETUP







- If a disc with a 16:9 aspect ratio and 96 kHz PCM sound is converted and played in the letter box format, the sampling frequency of the sound is downgraded to 48 kHz. To enjoy 96 kHz sound, set the screen aspect ratio to wide-screen.
- Whether the aspect ratio can be changed depends on the disc. Check the disc jacket for details.

Selecting the Aspect Ratio





DVD

Image Appearance

4:3 Aspect Ratio

Image Recorded on DVD	DVD-V7400 Settings	View Options
 <p>16:9 discs</p>	4:3 (Letter Box)	 <p>There are bars at the top and bottom but the full image is shown</p>
	4:3 (Pan & Scan)	 <p>The left and right sides of the screen are cut off but it can be seen properly</p> <p>Switch to 4:3 Letter Box for a full screen view</p>
	16:9 (Wide)	 <p>The image appears stretched or lengthened vertically</p> <p>Switch the player to 4:3 Letter Box or 4:3 Pan & Scan</p>
 <p>4:3 discs</p>	<p>4:3 (Letter Box) 4:3 (Pan & Scan) 16:9(Wide)</p>	 <p>The image appears properly</p>

Wide TV (16:9)

Image Recorded on DVD	DVD-V7400 Settings	View Options
 <p>16:9 discs</p>	16:9 (Wide)	 <p>The image appears properly There may be bands at the top and bottom depending upon the disc.</p>
 <p>4:3 discs</p>	16:9 (Wide)	 <p>There are bands at the right and left, but it can be seen properly</p>
		 <p>Appears to be stretched or lengthened horizontally The TV or viewing device must be adjusted rather than changing settings on the player. Refer to the device's Operating Instructions.</p>

NOTE

Displaying any of the following data or menus during playback in the Letter Box or Pan & Scan modes, force the screen to change to the wide-screen mode.

- Displaying the Setup menu
- Displaying the ADV.SETUP menu
- Displaying a command stack
- Displaying video blackboard
- Displaying the player control panel
- Displaying a Program
- Displaying video text

Changing Visual Settings

DVD

Switching Still Pictures

It is possible to eliminate any blurriness from the picture when a DVD is in Pause mode.

1 Press 

The initial setup menu is displayed.

2 Select [Video]

3 Select [Still Picture]

4 Press the arrow button  (right direction)

5 Select the preferred item

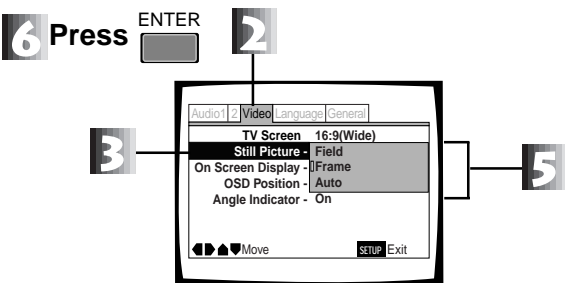

Field: Eliminates picture blurriness from a Still frame

Frame: Normal mode (default setting when shipped)

- Scenes with dynamic action may have jittering in a Still picture

Auto: Field and Frame automatically switch

7 Press 

Note

- Some discs may have a lower quality which is not corrected after selecting "Field". These discs are authored at a low bit rate.

DVD Video CD CD

Switching the Screen Display ON/OFF

To hide the status text (Play, Stop, etc.) during disc playback, turn the feature OFF.

1 Press 

The initial setup menu is displayed.

2 Select [Video]

3 Select [On Screen Display]

4 Press the arrow button  (right direction)

5 Select the preferred item

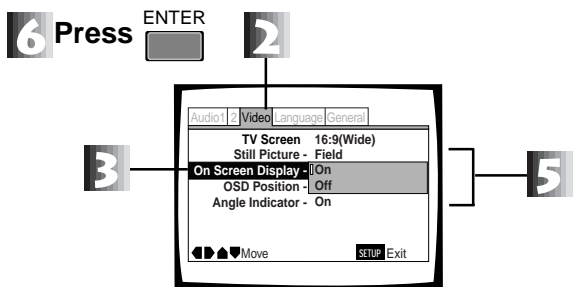

ON: Displays screen (default setting when shipped)

OFF: Hides text display

7 Press 

Changing Visual Settings

DVD

Selecting the Position of the On Screen Display (OSD)

The OSD position for the startup screen may be adjusted to fit properly on the display device. Set the screen ratio of a DVD disc to 4:3 (refer to the disc jacket for additional information).

1 Press  SETUP

The initial setup menu is displayed.

2 Select [Video]

3 Select [OSD Position]

4 Press the arrow button  (right direction)

5 Select the preferred position

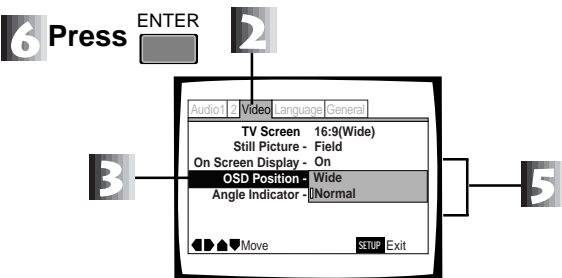

Wide: This setting avoids cutting off part of the OSD when the zoom option is activated on the wide-screen setting.

Normal: Select this when normal or full is chosen in combination with the wide-screen television view (default setting when shipped).

7 Press  SETUP

DVD

Turning the Mark ON/OFF

Change the setting to hide the camera mark from view  during regular playback.

1 Press  SETUP

The initial setup menu is displayed.

2 Select [Video]

3 Select [Angle Indicator]

4 Press the arrow button  (right direction)

5 Select the preferred item

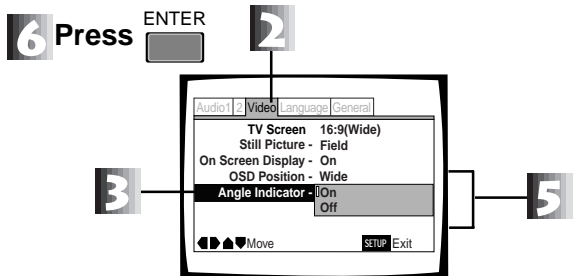

ON: Displays a  mark on the screen (default setting when shipped)

OFF: Hides the camera  mark

7 Press  SETUP

Setting the Language

Some DVD disks have multiple subtitles and audio tracks. The user is able to choose the appropriate combination. The settings related to the various languages and subtitles (in Language) under the initial Setup menu are reviewed below.

DVD

Setting the Audio Language

Select the audio language.
This setting is locked during playback.

1 Press **SETUP** 

The initial setup menu is displayed.

2 Select [Language]

3 Select [Audio Language]

4 Press the arrow button 
(right direction)

5 Select the preferred language

6 Press **ENTER** 

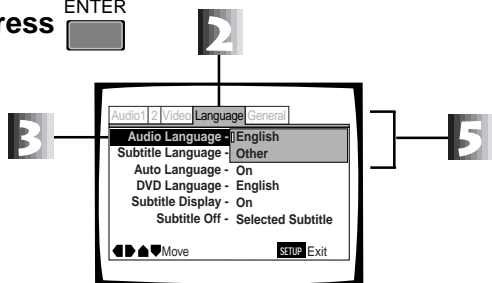

English: The default audio language is English.

Other: Select the desired audio from among 136 languages. For details, see "When [Other] is selected by the subtitle language/ audio language/DVD language setting" on the next page.

7 Press **SETUP** 

DVD

Setting a Subtitle Language

Select the subtitle language displayed.
This setting is locked during playback.

1 Press **SETUP** 

The initial setup menu is displayed.

2 Select [Language]

3 Select [Subtitle Language]

4 Press the arrow button 
(right direction)

5 Select the preferred language

6 Press **ENTER** 

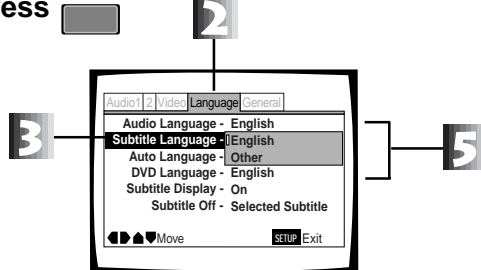

English: Displays English language subtitles (default setting when shipped)

Other: Select the desired subtitle from among 136 languages. For details, see "When [Other] is selected by the subtitle language/ audio language/ DVD language setting" on the next page.

7 Press **SETUP** 

Setting the Language

- When (Other) is selected for Subtitle language/ Audio language/ DVD language setting
Refer to the language code table on page 38.

1 Select [Other]

2 Press

The language setting screen is displayed.

Example: Audio Language is displayed

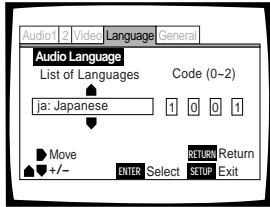





3 Select [List of Languages] or [Code]



- Selecting the language with the "List of Languages"
(When selecting "French")

Press  twice

- Selecting a language with the "Code"
(When selecting "French")

Press the following number combination   

 on the remote control.

- The numbers can also be selected by pressing   for each digit.

Pressing the   shifts the digit by one.

- The numbers in the () of the code indicate the range of available numbers.

4 Press

DVD

Automatically Setting an Audio Stream and Subtitles

The audio and subtitles can be selected automatically or from the initial startup function.

This setting is locked during playback.

1 Press

The initial setup menu is displayed.

2 Select [Language]

3 Select [Auto Language]

4 Press the arrow button (right direction)

5 Select the preferred option

6 Press

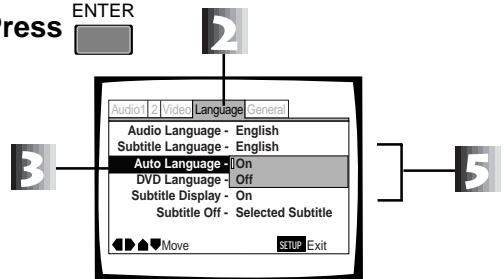

ON: This is effective when the audio language and the subtitle language are the same (subtitle display must be ON). With a foreign movie, the original language is selected for the audio and the subtitle selected on the [Subtitle Language] menu is shown. A domestic movie, the audio is set to the original language and the subtitles are set to OFF (default setting when shipped).

OFF: Automatic setting of the audio during playback is cancelled. The audio and subtitle language is controlled by the [Audio Language] and [Subtitle Language] selections.

7 Press

DVD

Setting the DVD Menu Language

Some DVDs have a menu. Select the language from this menu. This setting cannot be set during playback.

1 Press 

The initial setup menu is displayed.

2 Select [Language]

3 Select [DVD Language]

4 Press the arrow button  (right direction)

5 Select the preferred language

6 Press 

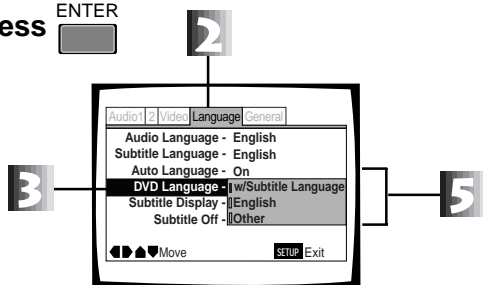

w/Subtitle

Language: Menu screen language displays according to the Subtitle Language setting (default setting when shipped).

English: The menu screen language is English.

Other: Select the desired language from among 136 languages. For details, see "When [Other] is selected by the subtitle language/audio language/DVD language setting" on page 28.

7 Press 

Note

If the selected language is missing from the disc, the menu screen displays in another language recorded on that disc.

DVD

Turning the Subtitle Display ON/OFF

The feature allows subtitles and/or "Assist Subtitle" to be shown. This setting is locked during playback.

1 Press 

The initial setup menu is displayed.

2 Select [Language]

3 Select [Subtitle Display]

4 Press the arrow button  (right direction)

5 Select the preferred language

6 Press 

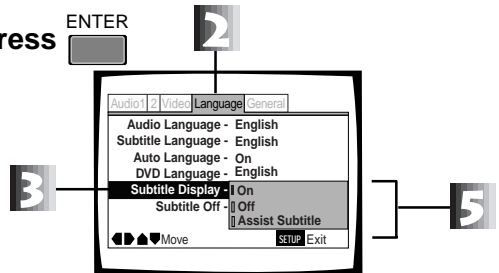

ON: The subtitles are displayed (default setting when shipped).

OFF: The subtitles are hidden. However, some DVDs enforce the display of subtitles (see the next page).

Assist Subtitle: This is a particular type of subtitle which displays for specific groups. Such as, explaining a scene for the deaf, etc. Subtitles are displayed when this setting is selected if they exist on the disc.

7 Press 

Setting the Language

DVD

Setting the Language of the Subtitles with Enforced Display

Some DVDs enforce the display of subtitles even when the Subtitle option is set to OFF. However, the language of the subtitles can still be selected by the normal method. This setting is locked during playback.

1 Press ^{SETUP} 

The initial setup menu is displayed.

2 Select [Language]

3 Select [Subtitle Off]

4 Press the arrow button 
(right direction)

5 Select the preferred language

6 Press ^{ENTER} 

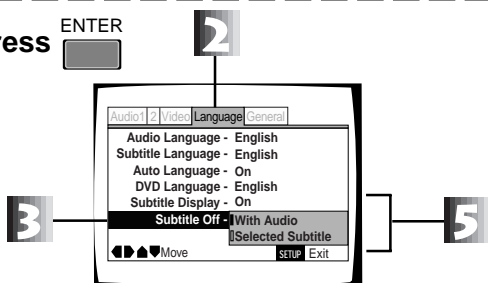

With Audio: Subtitles are matched to the audio stream language.

Selected Subtitle: Subtitles are in the language selected on the initial Setup menu (default setting when shipped).

7 Press ^{SETUP} 

Setting Viewing and Listening Restrictions (Parental Lock)

Some DVDs that contain violent scenes incorporate viewing restriction levels (1-8). This information is listed on the disc jacket. If the level of this player has been set to a level lower than the level of a disc, then the disc fails to play. For example, if the level of the player has been set to 6, a override code number has to be input before discs of levels 7 and 8 can be viewed.

DVD

Setting the Restriction Level

The level of the viewing/listening restrictions and the release code number are set manually.

1 Press

The initial setup menu is displayed.

2 Select [General] with

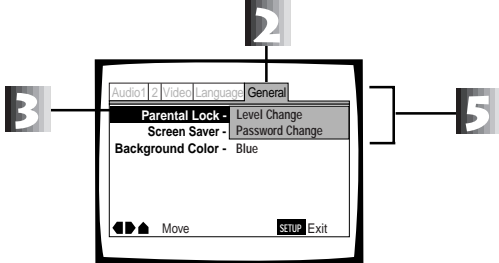

3 Select [Parental Lock] with

4 Press the arrow button (right direction)

5 Select [Level Change] with

before pressing 



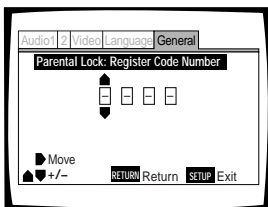

- When a code number has yet to be registered:
The code number registration screen is displayed.

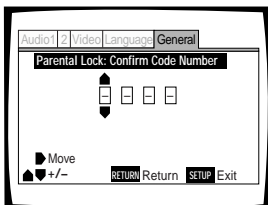

- When the code number has been registered:
The code number input screen is displayed.



6 Press the number buttons and enter a 4-digit code number

- Pressing   for each digit and selecting the numbers is also possible. Pressing   advances or reduces the number.

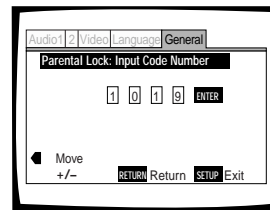

7 Press

- The viewing and listening restriction setting screen is displayed.
- The setting at the time of shipment is level 8 (unrestricted).

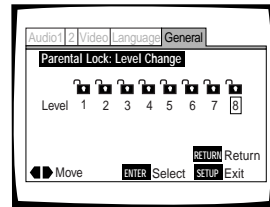

8 With , select the appropriate number for the level

- For example, if level 6 has been selected, viewing and listening restrictions are applied to discs marked as level 7 or 8.

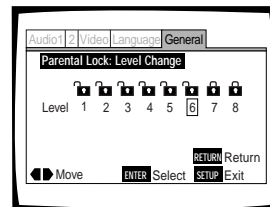

9 Press

The level of the viewing and listening restrictions is set.

Notes:

If the code number is forgotten or misplaced, return to the default setting (page 38) and reset to a new code.

Setting Viewing and Listening Restrictions (Parental Lock)

DVD

When a DVD with a Set Parental Lock is Loaded

Loading a DVD with an active Parental Lock brings up the password input screen if the disc is a higher level than the player. Playback begins when the correct code is input.

1 Press the number buttons to input the 4-digit code number

- Pressing for each digit and selecting the numbers is also possible. Pressing advances or reduces the number.

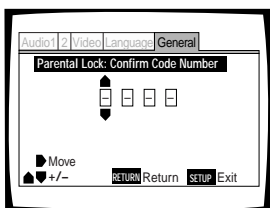

2 Press ENTER

Playback starts

Note:

Some discs skip while playing back only the scenes with viewing and listening restrictions. See the operation method included with the disc for details.

DVD

Changing the Code Number

1 Perform the previous instructions, 1 ~ 4 "Setting the Restriction Level" on the previous page

2 Press , select [Password Change] and press ENTER

The code number input screen is displayed.

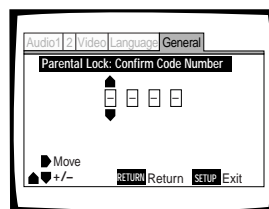

3 Press the number buttons and enter the present 4-digit code number

- Pressing for each digit and selecting the numbers is also possible. Pressing advances or reduces the number.

4 Press ENTER

The code number changing screen is displayed.

5 Press the number buttons and input the new 4-digit code number

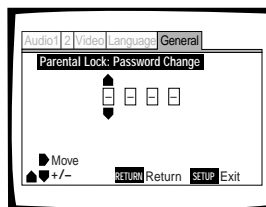

6 Press ENTER

The code number is changed.

Making Standard Settings

DVD Video CD CD

Setting the Screen Saver

The screen saver is a function to prevent the burning in (the afterglow phenomenon) of an image when the same image has been displayed for a long time such as during a pause.

1 Press 

The initial setup menu is displayed.

2 Select [General]

3 Select [Screen Saver]

4 Press the arrow button 
(right direction)

5 Select the preferred item

6 Press 

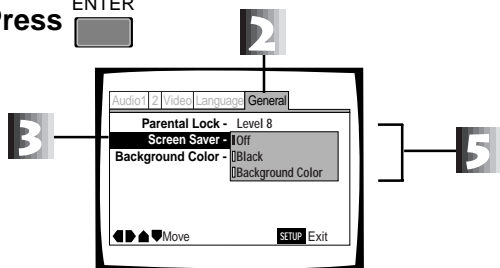

- OFF Screen Saver is deactivated (default setting when shipped)
- Black: Screen saver set to black
- Background Color: Screen saver set to a selected color

7 Press 

DVD Video CD CD

Select the Background Color

Select a screen for when the disc is stopped.

1 Press 

The initial setup menu is displayed.

2 Select [General]

3 Select [Background Color]

4 Press the arrow button 
(right direction)

5 Press 

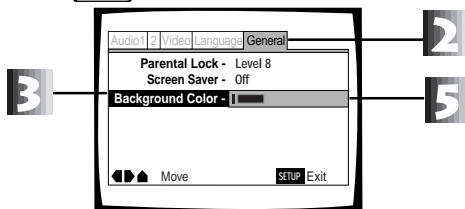

6 Adjust the screen color from the menu and press 

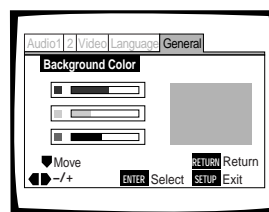

7 Press 

Setting the Digital Output

The type of digital signal corresponding to the amplifier can be selected through the player. Improper settings may cause noise or feedback. Review the information below and refer to the Operating Manual for the amplifier.

DVD

Dolby Digital Output

If the amplifier does not support Dolby Digital*, select the [Dolby Digital ► PCM] setting.

1 Press  **SETUP**

The initial Setup menu is displayed.

2 Select [Audio 1]

3 Select [Dolby Digital Out]

4 Press the arrow button  (right direction)

5 Select the preferred item

6 Press  **ENTER**

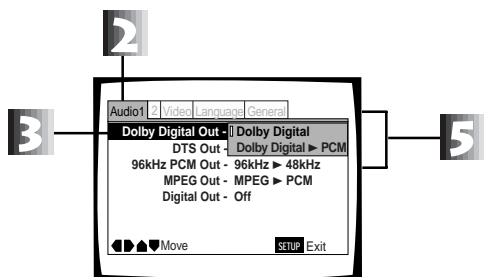

Dolby Digital: For amplifiers and decoders which support Dolby Digital (default setting when shipped)

Dolby Digital ► PCM: Converts a Dolby Digital signal to a linear PCM signal if the amplifier does not support Dolby Digital technology

7 Press  **SETUP**

* Manufactured under license from Dolby Laboratories. "Dolby" and the double-D symbol are trademarks of Dolby Laboratories. Confidential unpublished works. © 1992-1997 Dolby Laboratories. All rights reserved.

DVD

DTS Output

When the connected amplifier supports DTS**, set to [DTS].

1 Press  **SETUP**

The initial setup menu is displayed.

2 Select [Audio 1]

3 Select [DTS Out]

4 Press the arrow button  (right direction)

5 Select the preferred output

6 Press  **ENTER**

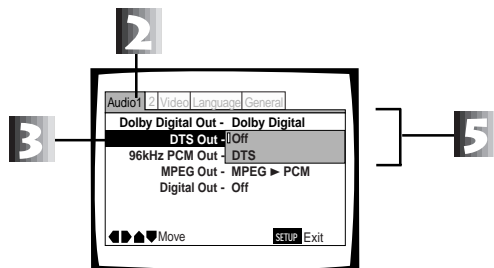

OFF: For amplifiers that do not support DTS (default setting when shipped)

DTS: For amplifiers and decoders which support DTS output

7 Press  **SETUP**

** "DTS" and "DTS Digital" are trademarks of Digital Theater Systems, Inc. Manufactured under license from Digital Theater Systems, Inc.

DVD

96 kHz PCM Output

When the connected amplifier supports 96 kHz, set to (96 kHz). This setting is locked during playback.

1 Press 
The initial setup menu is displayed.

2 Select [Audio 1]

3 Select [96kHz PCM Out]

4 Press the arrow button 
(right direction)

5 Select the preferred output

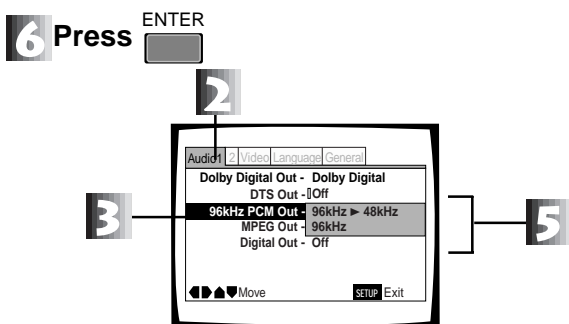

96 kHz ▶ 48 kHz: Down-samples a 96 kHz signal to a 48kHz output if the amplifier does not support 96 kHz (default setting when shipped)

96 kHz: For amplifiers or DACs which supports 96 kHz

7 Press 

DVD

MPEG Output

When the connected amplifier supports MPEG, set to (MPEG).

1 Press 
The initial setup menu is displayed.

2 Select [Audio 1]

3 Select [MPEG Out]

4 Press the arrow button 
(right direction)

5 Select the preferred output

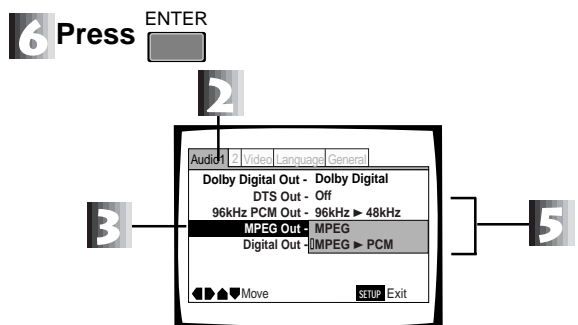

MPEG: For amplifiers or decoders which supports MPEG

MPEG ▶ PCM: Converts an MPEG signal to a linear PCM signal if the amplifier does not support MPEG (default setting when shipped)

7 Press 

Setting the Digital Output

DVD Video CD CD

Setting the Digital Output

The digital audio output terminal can be set so that the player ignores an audio signal.

1 Press 

The initial setup menu is displayed.

2 Select [Audio 1]

3 Select [Digital Out]

4 Press the arrow button  (right direction)

5 Select the preferred output

6 Press 

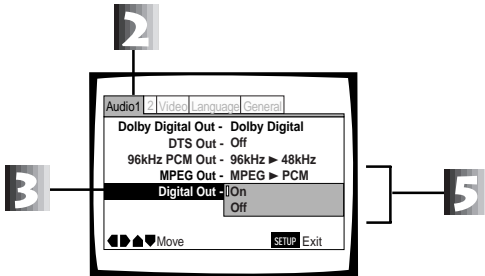

ON: Outputs audio from the rear digital output terminal (default setting when shipped)

OFF: Audio is blocked from the rear digital output terminal

7 Press 

Settings to Optimize the Audio Quality

DVD Video CD

Surround Sound Setting

This player automatically switches to Virtual Dolby Digital and TruSurround depending upon the selected audio stream.

1 Press 

The initial setup menu is displayed.

2 Select [Audio 2]

3 Select [Virtual Surround]

4 Press the arrow button  (right direction)

5 Select [VDD/TruSurround]

6 Press 

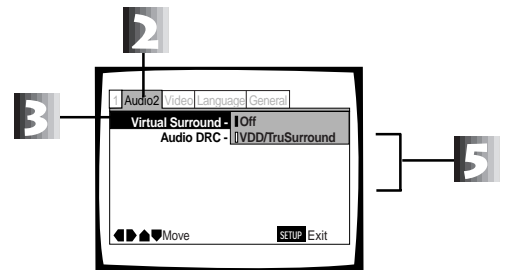

OFF: Auto-switching is off (default setting when shipped)

VDD/TruSurround: Surround sound setting

7 Press 

TruSurround and Virtual Dolby Digital

This player, by means of the TruSurround* technology, processes surround encoded stereo audio and multi-channel audio as well as providing Virtual Surround through the two front speakers.

The Virtual Dolby Digital functions automatically for a surround sound with greater sense of presence than the stereo speaker system.

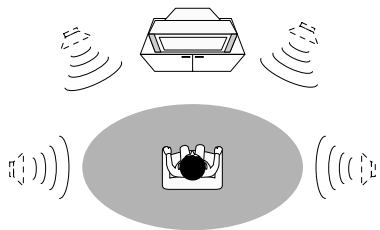

TruSurround™

* TruSurround and the symbol (●) are trademarks of SRS Labs, Inc. in the United States and selected foreign countries. TruSurround technology has been commercialized by means of a license from SRS Labs, Inc.

Note

- This function is unavailable when the DVD DTS audio and 96 kHz PCM is selected or when a CD is played.
- When **AUDIO** on the remote control is pressed (in the Virtual Dolby Digital mode) VDD is visible on the screen (upper right).
- When Audio 1 [Dolby Digital Output] on the initial Setup menu is set to [Dolby Digital ► PCM] in Virtual Dolby Digital mode, audio is blocked from the digital output terminal (page 34).
- The surround effect of some discs may be limited depending upon how the disc was produced.

DVD Video CD CD

Dynamic Range Compression Setting

This function allows the dynamic range of the audio soundtrack to be adjusted, loud volume lower and low volume louder. When Audio DRC (Dynamic Range Compression) is ON, soft sounds such as dialogue are heard more clearly without increasing loud sounds on the same track.

1 Press **SETUP**

The initial setup screen is displayed.

2 Select **[Audio 2]**

3 Select **[Audio DRC]**

4 Press the arrow button **(right direction)**

5 Select the preferred setting

6 Press **ENTER**

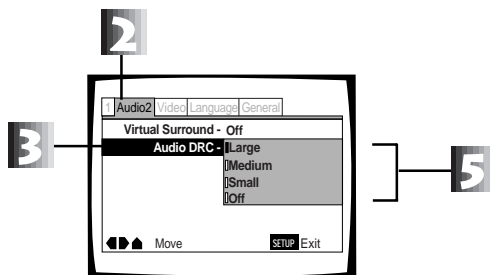

Large: Maximum compression of audio source
Medium: Moderate compression of audio source
Small: Minimum compression of audio source
Off: Cancel the audio DRC (default setting when shipped)

7 Press **SETUP**

Note

- Audio DRC is only effective with Dolby Digital audio sources.
- Audio DRC effects depend on which speakers and amplifier are used. Adjust the setting of the amp and speaker to the most effective setting.

Returning to the Factory Default Settings from Time of Shipment

DVD Video CD CD

All the settings can be returned to the factory default.

Returning the settings to the default values, erases all data stored in the memory simultaneously (page 18). Record any vital information before issuing this command.

1 With the player in the Standby, press and hold the left scan  button and press power  button.

Some values are reset to the default settings prior to shipment.

Settings returned to the default:

1) SETUP menu, 2) ADV. SETUP menu, 3) Program memory, 4) Parental Lock

Settings maintained at last value:

1) Command stack, 2) Video blackboard data, 3) Clock

Language Code List

DVD

Language (Language code)	Input code
Japanese (ja)	1001
English (en)	0514
French (fr)	0618
German (de)	0405
Italian (it)	0920
Spanish (es)	0519
Dutch (nl)	1412
Russian (ru)	1821
Chinese (zh)	2608
Korean (ko)	1115
Greek (el)	0512
Afar (aa)	0101
Abkhazian (ab)	0102
Afrikaans (af)	0106
Amharic (am)	0113
Arabic (ar)	0118
Assamese (as)	0119
Aymara (ay)	0125
Azerbaijani (az)	0126
Bashkir (ba)	0201
Byelorussian (be)	0205
Bulgarian (bg)	0207
Bihari (bh)	0208
Bislama (bi)	0209
Bengali (bn)	0214
Tibetan (bo)	0215
Breton (br)	0218
Catalan (ca)	0301
Corsican (co)	0315
Czech (cs)	0319
Welsh (cy)	0325
Danish (da)	0401
Bhutani (dz)	0426
Esperanto (eo)	0515
Estonian (et)	0520

Language (Language code)	Input code
Basque (eu)	0521
Persian (fa)	0601
Finnish (fi)	0609
Fiji (fj)	0610
Faroese (fo)	0615
Frisian (fy)	0625
Irish (ga)	0701
Scots-Gaelic (gd)	0704
Galician (gl)	0712
Guarani (gn)	0714
Gujarati (gu)	0721
Hausa (ha)	0801
Hindi (hi)	0809
Croatian (hr)	0818
Hungarian (hu)	0821
Armenian (hy)	0825
Interlingua (ia)	0901
Interlingue (ie)	0905
Inupiak (ik)	0911
Indonesian (in)	0914
Icelandic (is)	0919
Hebrew (iw)	0923
Yiddish (ji)	1009
Javanese (jw)	1023
Georgian (ka)	1101
Kazakh (kk)	1111
Greenlandic (kl)	1112
Cambodian (km)	1113
Kannada (kn)	1114
Kashmiri (ks)	1119
Kurdish (ku)	1121
Kirghiz (ky)	1125
Latin (la)	1201
Lingala (ln)	1214
Laothian (lo)	1215

Language (Language code)	Input code
Lithuanian (lt)	1220
Latvian (lv)	1222
Malagasy (mg)	1307
Maori (mi)	1309
Macedonian (mk)	1311
Malayalam (ml)	1312
Mongolian (mn)	1314
Moldavian (mo)	1315
Marathi (mr)	1318
Malay (ms)	1319
Maltese (mt)	1320
Burmese (my)	1325
Nauru (na)	1401
Nepali (ne)	1405
Norwegian (no)	1415
Occitan (oc)	1503
Oromo (om)	1513
Oriya (or)	1518
Panjabi (pa)	1601
Polish (pl)	1612
Pashto, Pushto (ps)	1619
Portuguese (pt)	1620
Quechua (qu)	1721
Rhaeto-Romance (rm)	1813
Kirundi (rn)	1814
Romanian (ro)	1815
Kinyarwanda (rw)	1823
Sanskrit (sa)	1901
Sindhi (sd)	1904
Sangho (sg)	1907
Serbo-Croatian (sh)	1908
Sinhalese (si)	1909
Slovak (sk)	1911
Slovenian (sl)	1912
Samoan (sm)	1913

Language (Language code)	Input code
Shona (sn)	1914
Somali (so)	1915
Albanian (sq)	1917
Serbian (sr)	1918
Siswati (ss)	1919
Sesotho (st)	1920
Sundanese (su)	1921
Swedish (sv)	1922
Swahili (sw)	1923
Tamil (ta)	2001
Telugu (te)	2005
Tajik (tg)	2007
Thai (th)	2008
Tigrinya (ti)	2009
Turkmen (tk)	2011
Tagalog (tl)	2012
Setswana (tn)	2014
Tonga (to)	2015
Turkish (tr)	2018
Tsonga (ts)	2019
Tatar (tt)	2020
Twi (tw)	2023
Ukrainian (uk)	2111
Urdu (ur)	2118
Uzbek (uz)	2126
Vietnamese (vi)	2209
Volapük (vo)	2215
Wolof (wo)	2315
Xhosa (xh)	2408
Yoruba (yo)	2515
Zulu (zu)	2621

Advanced Feature Operations

For fundamental operations, refer to the beginning of this manual (Basic Operation). This portion details the advanced features on the DVD-V7400 player.

● Using the ADV.SETUP Menu

In addition to the SETUP menu, this player has an ADV.SETUP menu supporting special functions such as the weekly timer and Power-ON start.

● Player Control Using the Mouse

Control using the mouse is explained in this section.

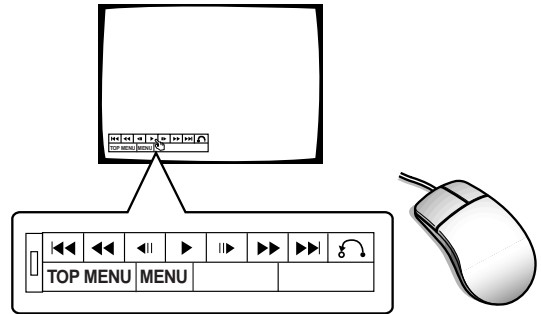

● Barcode/Command Stack Function

Barcodes and commands can be stored in the player's memory. The memorized content may be recalled for successive or step by step execution. program playback is possible using the player alone without the need for a computer, controller or advancement registration of barcodes. Memorized data is help even if the power cord is unplugged.

Uses

- Sale Promotion Presentation
- Picture Reference/Picture Exhibition
- Education/Training

Input

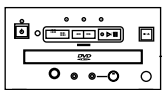
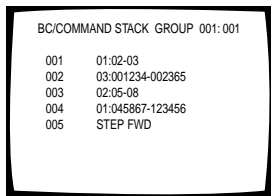

Input

Command input through the remote control (provided)

Input

Barcode input with barcode reader (purchased separately)



Playback

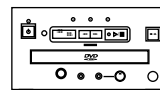
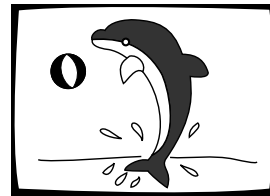

Automatic Playback

- Remote Control
- External Option Switch
- Successive playback/repeat with Weekly timer/Power ON start

Manual Playback

Step by step playback with remote control

● Video Blackboard Function

Use the mouse or keyboard to draw pictures and lines or type characters (alphabet, numbers, symbols) during video playback or to be shown alone.

Free-hand lines can be drawn on the picture during playback, and pre-drawn graphics or characters can be superimposed over the image and displayed at a specific point.

How to use

- A pointer
- For a picture subtitle
- For an explanation
- To mask a picture

Uses

- Sale promotion presentation
- Education/training

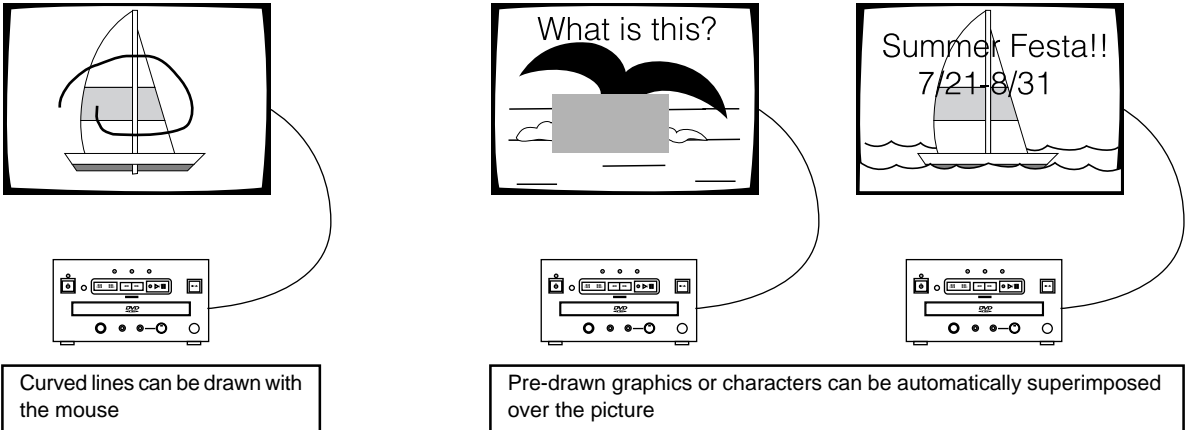

● External Synchronizing Function

● Playback Time/Power Supply Time Display

ADV. SETUP MENU settings

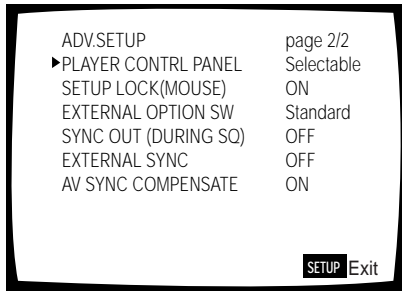
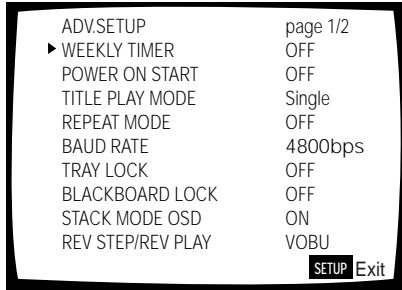

Above picture indicates the initial settings.

DVD Video CD CD

To Access the ADV. SETUP menu

Press and hold **SETUP** for one second

The Advanced Setup (ADV.SETUP) menu is shown to the left.

To set a parameter, such as the weekly timer, select **WEEKLY TIMER** with **▲ ▼**, set ON/OFF with the **◀ ▶**. If a parameter is set ON, press **ENTER** and perform the setting instructions as prompted on the screen.

For Power-ON Start, select **POWER ON START** with the **▲ ▼**, set ON/OFF with the **◀ ▶**. If a parameter is set ON, press **ENTER**, set ON/OFF to ON and perform the setting instructions as prompted on the screen.

A similar procedure is used to set the other parameters with **▲ ▼** and set ON/OFF with the **◀ ▶**.

In order to set up the unique functions on the DVD-V7400, there are settings for 16 parameters available through the remote control.

① WEEKLY TIMER

A timer for turning the power ON and OFF can be set for each day of the week; as well as setting the title and chapter. The player is limited to a maximum of 24 settings of unmanned operations at a time.

OFF: WEEKLY TIMER is deactivated

ON: WEEKLY TIMER is available

② POWER ON START

This function sets whether or not automatic playback is to start when the power is switched ON.

OFF: POWER ON START is deactivated

ON: POWER ON START is available

It is necessary to identify the Title and Chapter as a starting point for playback. If this starting point is not identified, the player waits in the Stop mode.

③ TITLE PLAY MODE

Single: When a single Title has been selected, the DVD player stops at the end of that Title.

All: Each Title on a DVD disc plays before the player stops.

④ REPEAT MODE

Select OFF/CHAPTER/TITLE/DISC from the menu.

Set ALL,DISC under the TITLE PLAY MODE option

OFF: Title(s) plays back once and does not repeat (DVD, Video CD, CD)

CHAPTER: The selected chapter only repeats (DVD)
One selected track only repeats (Video CD, CD)

TITLE: The selected Title repeats (DVD)
The entire disc repeats (Video CD, CD)

DISC: The entire disc repeats (DVD only)

⑤ BAUD RATE

This sets the baud rate of the RS-232C interface at either 4800 bps or 9600 bps.

⑥ TRAY LOCK

When set to ON, the disc tray ignores request to open or to close.

⑦ BLACKBOARD LOCK

When set to ON, video blackboard input is ignored.

⑧ STACK MODE OSD

This switches the OSD ON/OFF during stack playback.

ON: The STACK display appears on screen when executing or search a stack.

OFF: The STACK display is hidden.

ADV. SETUP MENU settings

⑨ REV STEP/REV PLAY

This selects the image segment(s) for reverse play

VOBU: Usually the reverse segments are in blocks of 0.4 - 1 second

Frame: Reverses at intervals of one frame

⑩ PLAYER CONTROL PANEL

This command reveals the or hides the icon panel and is controlled with a mouse.

Selectable: Click the left and right mouse buttons simultaneously, or with the left button held down, click the right button to display the icon control panel.

Always On: The icon control panel is shown except during some Setup actions and views.

Always Off: The icon control panel is hidden.

⑪ SETUP LOCK (MOUSE)

This function allows the SETUP or ADV.SETUP menu to be activated from the icon control panel.

ON: The SETUP or ADV.SETUP menu are unavailable from the icon control panel.

OFF: Left-mouse-clicks activate the appropriate menu, SETUP menu or ADV.SETUP menu.

⑫ EXTERNAL OPTION SW

This is used to set the key of the external option switch.

Standard: Input of all external option keys is possible.

Limit: Only the following input is possible with the external option keys:

Up/down/left/right cursor, ENTER, number keys 1-6, STACK GROUP 1-6, TOP MENU, and MENU

Note: For more information on External Switch Control, refer to the DVD-V7400 SCSI Command Protocol Manual - Jama control.

⑬ SYNC OUT (DURING SQ)

This function controls whether a video synchronization signal is output to a black screen or to a blue background when the player is not withholding any video output.

OFF: Video is always output (the synchronization signal remains)

ON: Video is withheld when the menu screen is shown or when playback is stopped.

⑭ EXTERNAL SYNC

This selects the synchronized TV signal format when external synchronization is input.

OFF: This setting blocks external synchronizing

PAL : When a PAL format DVD disc is played back

NTSC: When a NTSC format DVD disc is played

⑮ AV SYNC COMPENSATE

This function allows external synchronization when the player is used alone or when multiple units are daisy-chained or linked with video frames matched.

ON: When using the player by itself

OFF: When multiple units are operated side by side (linked) and the video frames are aligned

Note

The following functions are locked during playback. To make changes, the player must be in the Stop mode.

- REV STEP/REV PLAY
- EXTERNAL SYNC
- AV SYNC COMPENSATE



Player Control Using a Mouse

Connect a PS/2 mouse before turning the power ON.

DVD Video CD

Button Selection



Use the mouse to select DVD Menu buttons and buttons displayed on the screen.









When the cursor is placed on a button, it changes from  to the  mark. While the cursor is displayed as the  mark, clicking on a button with the left mouse button is identical to making a selection from the remote control.

* Menu selection with a mouse is invalid on a Video CD.

DVD Video CD CD

Player Control Icon

Pressing the mouse's left and right button simultaneously or clicking the right button while holding the left button displays the player control icons on the bottom left of the screen. When the mouse pointer is placed on a player control icon, the pointer changes from  to . While the cursor is in this form, , clicking with the left mouse button performs the same operation as the button on the remote control.

Function \ Discs	DVD	Video CD	CD
	YES	YES	YES
	YES	YES	YES
	YES	YES	NO
	YES	YES	YES
	YES	NO	NO
	YES	YES	YES
	YES	YES	YES
	YES	YES	NO
TOP MENU	YES	NO	NO
MENU	YES	NO	NO

- Buttons may appear anywhere within the viewing area on a commercially produced DVD. Please use the remote control instead of the mouse with such discs.

Controlling a DVD Disc

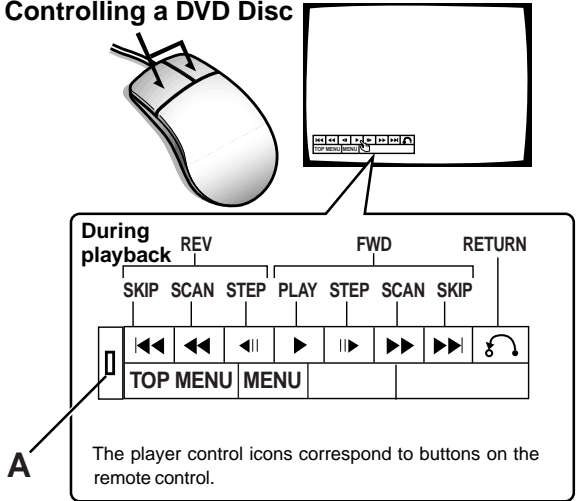

- When SETUP LOCK (MOUSE) on the ADV. SETUP menu is set to OFF, the SETUP and ADV. SETUP buttons appear on the player control panel. You can click these buttons with the mouse to enter the corresponding SETUP menu.
- When SETUP LOCK (MOUSE) is set to OFF and point "A" is dragged while holding the left mouse button down, the player control panel can be moved. Once the panel location is changed, the new location is maintained until the power is turned OFF. The default panel position is restored when the power is turned back ON. The same reaction happens when the OSD position is changed or when the video blackboard is displayed.

NOTE

- The position of the player control panel is locked during PAL disc playback.
- The position of the player control panel is locked when the [OSD Position] in the SETUP MENU is set to [Wide] or when the video blackboard is displayed.

Controlling a Video CD

A left mouse click fails to select Video Titles. Right-clicking the player control icon (see below) displays a Title number in the upper right corner of the screen. Additional clicks change this number. To begin video playback, press  and the selected Title is shown.

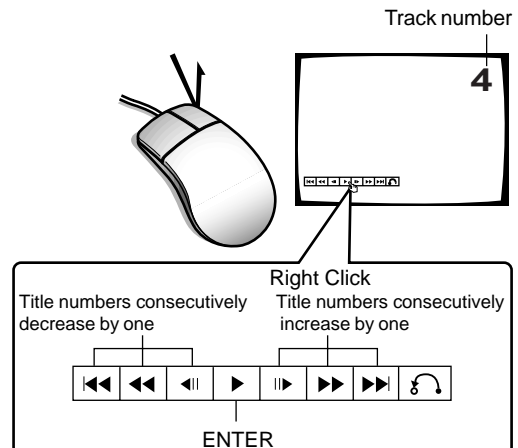

Note

If the Title number is invalid or mouse operation is prohibited, the request fails to execute.

Weekly Timer Function Operation/Display

1

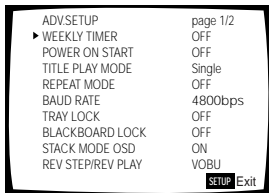

2

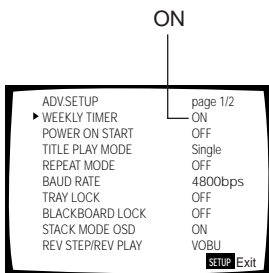

3-4

1/3 shows that there are 3 pages of setting, and that this screen is the first of those pages.

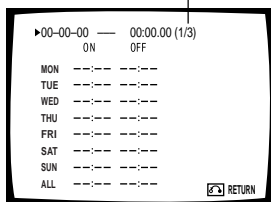

5

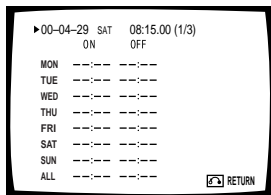

Tip

- The internal clock has a tolerance of approximately ± 2 minutes per month. (The amount varies depending on the usage environment).
- The built-in clock is powered by a capacitor thus continues to function when the player is in the STANDBY mode. But the AC power cord must be plugged in. If the power cord is unplugged, the clock continues to run for 7 to 10 days only (when the capacitor is fully charged and at an approximate temperature of 77°F).
- The weekly timer setting is stored in memory.

DVD Video CD CD

Setting/Correcting the Current Time

Set the current date and time.

- 1 Move the **▶** (pointer) to "WEEKLY TIMER" by pressing **▲** or **▼**
2. Press **◀** or **▶** and set to ON
3. Press **ENTER**
 - The Weekly Timer setting screen displays.
4. Press **ENTER**
 - The date/time setting screen displays but blinking.
5. Set the time of the day
 - Set figures in order of year (2 digits), month, day, day of the week, hour, minute and second.

These figures can be input in either of the following two methods.

A. Input using the numeric buttons and **NEXT** **▶▶**

B. Input using **▲** or **▼** and **ENTER**

"A" and "B" in the following example refers to the two operation methods listed above.

Example) To set to 8:15:00, Saturday April 29, 2000

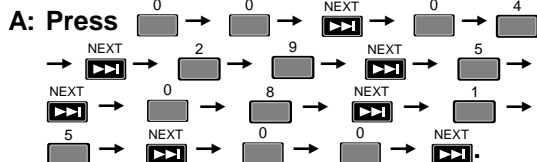

*days of the week can be set using the following numeric buttons

MON: 0, TUE: 1, WED: 2, THU: 3,
FRI: 4, SAT: 5, SUN: 6.

B: Press the **▲** or **▼** to select 00 and press **ENTER** to start the setting of the next set of figures (in this case, the month). Set month, date, day of week, hour, minute and second before pressing **ENTER** to complete the setting operation.

To correct the date or time

When the setting screen appears in step 3 above, press **ENTER**

When the year starts to blink on and off, press **NEXT** **▶▶** four times so that the hour blinks. Set all figures with this same method.

Setting the Weekly Timer

1 When the setting screen appears at step 3 on the previous page, press or to move (pointer) to the day of the week and press

- Power ON/OFF time setting display appears

2. Set the power ON/OFF time

Example 1: To turn power ON at 10:30AM on Wednesday

- Move (pointer) to "WED" and press

A: Press → → → → → →

B: Press or to select 10 and press to save the setting and continue to the next figures. Press or to set it to 30 and press twice.

- If the power OFF time is not set, the timer simply powers ON

Example 2: To turn power ON at 10:30AM on Wednesday and turn it OFF at 5:45PM (17:45)

A: Press → → → → → → → → → → → →

B: Press or to select 10 and press to save the setting and continue to the next set. Set the subsequent figures to 30, 17 and 45 by repeating the above.

NOTE:

It is also possible to set only the power OFF time without a power ON time. In this case, when power is turned ON manually, it is automatically turned OFF at the set time.

- The WEEKLY TIMER may be set using the mouse as well as with the remote control.
- When displays, clicking with the left mouse button changes selections or settings.
- Each time you click the left mouse button, the numerical value is increased by one, Each time you click the right button, the numerical value is decreased by one.

1

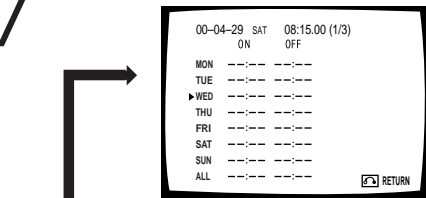

RETURN

ENTER

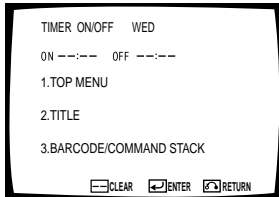

2

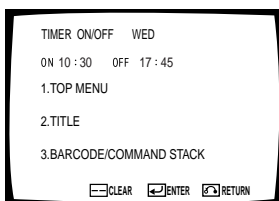
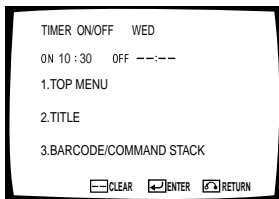

- Select ENTER on the screen to create the setting and exit the screen. Select RETURN to cancel the setting and return to the previous screen.

Weekly Timer Function Operation/Display

3

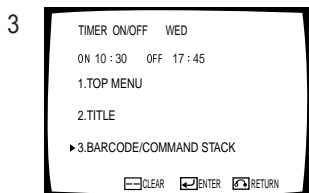
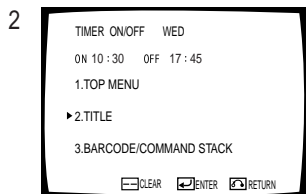
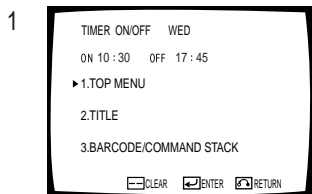

or reference

Memorized data is not erased even if AC power cord is unplugged

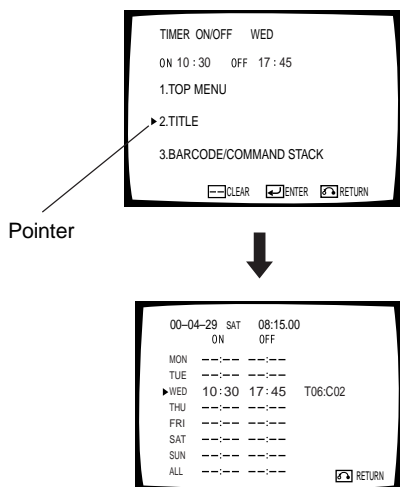

- Select ENTER on the screen to save the setting and exit the screen.
- Select RETURN to cancel the setting and return to the previous screen.

3. Set the operation which begins when the timed playback starts

- 1. TOP MENU:** Setup for playing from top of the menu
- 2. TITLE:** Setup for playing a specified Title and Chapter - Refer to "Playing the Specified Title and Chapter" (see below)
- 3. BARCODE COMMAND STACK:** Setup for recalling the barcode command stack groups from player memory - Refer to "Setup for Recalling the Barcode/Command Stack Groups from Memory" (see page 47) - Select one of the above with or , press the button.

NOTE

- The power ON time has to be set prior to this action.
- The data is written in memory at the moment the timer setup screen is exited. The timer setup is erased from memory if the power is turned OFF before exiting.
- A DVD disc with automatic playback ignores the Timer Setup feature.

DVD Video CD CD

Clearing the Set Time

With the **TIMER ON/OFF** input screen (shown left) showing, press then press on the remote control.

DVD Video CD CD

Playing a Specified Title and Chapter

- Move (pointer) to "2 TITLE" and press

Example: To playback of Title 6, Chapter 2

A: Press → → → →

→

B: Press or to select 06 and press to advance to the next set of figures. Press the buttons, or , to select 02 and press

NOTE

- When a Title and Chapter are selected, playback continues after the selected chapter if there is one or more chapters following it. Playback stops at the end of the Title. If repeat playback is selected in the ADV SETUP menu, the Chapter plays first then loops to play again.
- When specifying tracks on a CD or Video CD, enter the track number in the CHAPTER in the above setting. At this time TITLE and BARCODE/COMMAND STACKS settings will not operate.

DVD Video CD CD

Setting to Turn ON Player Power Only

When selecting a Title, enter a Title which is missing from the disc.
Example: Enter Title 99

DVD



Setup for Recalling the Barcode/Command Stack Groups from Memory

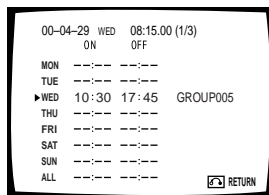
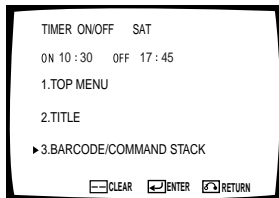

• Move the pointer to #3, BARCODE/COMMAND STACK, press 

Example: To recall and execute Barcode/Command Stack Group number 5



- Select ENTER on the screen to enter the setting and exit the screen. Select RETURN to cancel the setting and return to the previous screen.

A: Press  → 

B: Press  or  to select 005 then press the  button.





Now the timer setting is complete.

NOTE

When a Barcode Command Stack Group is selected, the stack within the group is executed repeatedly regardless of whether the Repeat mode in the ADV SETUP menu is ON or OFF.

DVD Video CD CD

Setting the Timer Function Without effecting Weekly Timer Setting

- 1 Move the ► (pointer) to WEEKLY TIMER on the ADV SETUP menu screen with  or . Set the timer to OFF with the direction button  or  on the remote control.

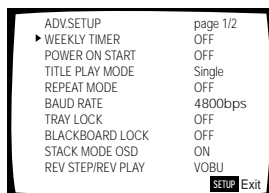

Weekly Timer Function Operation/Display

DVD VideoCD CD

Setting the WEEKLY TIMER and Expandable Functions

This setting allows for the power to be turned ON and OFF more than two times during the same day. The ALL setting triggers the player to turn ON and OFF at the same time each day.

DVD VideoCD CD

Setting the Day for the WEEKLY TIMER

1. Select the WEEKLY TIMER setup screen

- For information on how to select this screen, see page 44 and 45.

2. When the setting options begin blinking, press the **PREV** button.

- The setting that indicates the day of the week begins to blink.

3. Select a day by using **▲** or **▼**

Press the scrolling buttons **▲** or **▼** to view the eight available day settings: **ALL**, **MON**, **TUE**, **WED**, **THU**, **FRI**, **SAT**, and **SUN**. For information relating specifically to the WEEKLY TIMER when ALL is selected, see page 49.

4. Press **NEXT**

- For information on how to activate the timer and other settings, refer to page 45.

An alternative to the Remote Control is a **PS/2 (or compatible) mouse**. Position the cursor over the appropriate Day then click the left mouse button to select that Day.

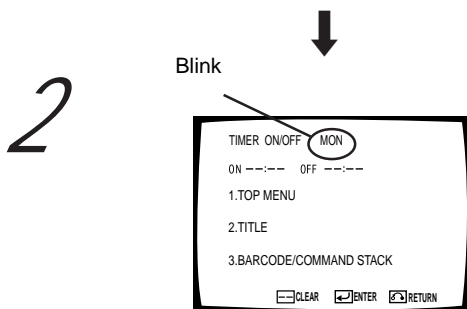
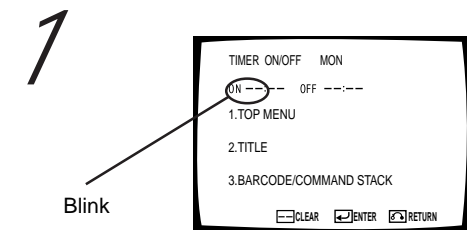

▲ or ▼ ↓
Display changes MON ~ ALL

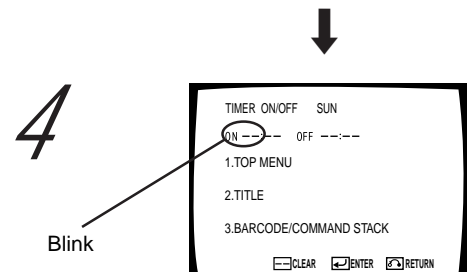
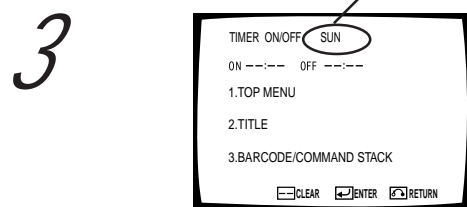

- Select ENTER on the screen to save the setting and exit the screen. Select RETURN to cancel the setting and return to the previous screen.

DVD Video CD CD

Setting the Power to Turn ON and OFF more than twice in the same day

Example 1:

When set as seen in Example 1, the power turns ON at 7:30 a.m. on Sunday and playback begins from the first Title Chapter (track). The power then turns OFF at 12:00 noon. At 1:00 p.m. on Sunday, the power turns ON again and playback begins from the second Title Chapter (track). The power then turns OFF at 5:30 p.m. The player can be set to turn ON and OFF up to twenty-four times during a single day.

DVD Video CD CD

Setting the Player to turn ON and OFF at the same time every day

Example 2:

In Example 2, the power turns ON everyday at 7:30 a.m. and playback begins from the first title chapter (track). The power automatically turns OFF at 5:30 p.m. When the day is set to ALL (see page 48), the timer power settings (ON/OFF) are available.

Example 3:

Similar to Example 2, set the power ON and OFF times every day, except Sunday. Then match the time in the OFF column for Sunday to the time in the ON column for ALL; leave the Sunday time setting in the ON column blank.

In Example 3, the power on Sundays is OFF, while on the remaining days the power turns ON at 7:30 a.m. with playback beginning at the first Title Chapter (track) and power turning OFF at 5:30 p.m.

DVD Video CD CD

Setting the Power to turn ON One Day and OFF on Another

Example 4:

The power turns ON at 11:00 p.m. on Monday and turns OFF 2:00 a.m. on Tuesday.

Example 1:

00-04-29	SAT	08:15.00 (1/3)
	ON	OFF
MON	----	----
TUE	----	----
WED	----	----
THU	----	----
FRI	----	----
SUN	07:30	12:00 T01: C01
▶SUN	13:00	17:30 T02: C01
ALL	----	----

List display

Example 2:

00-04-29	SAT	08:15.00 (1/3)
	ON	OFF
MON	----	----
TUE	----	----
WED	----	----
THU	----	----
FRI	----	----
SAT	----	----
SUN	----	----
▶ALL	07:30	17:30 T01: C01

List display

Example 3:

00-04-29	SAT	08:15.00 (1/3)
	ON	OFF
MON	----	----
TUE	----	----
WED	----	----
THU	----	----
FRI	----	----
SAT	----	----
▶SUN	----	07:30
ALL	07:30	17:30 T01: C01

List display

Example 4:

00-04-29	SAT	08:15.00 (1/3)
	ON	OFF
MON	23:00	----
TUE	----	02:00
WED	----	----
THU	----	----
FRI	----	----
SAT	----	----
▶SUN	----	----
ALL	----	----

DVD Video CD CD

Examples of Timer Settings for the WEEKLY TIMER Overlap

Example 5:

When the following settings are selected for the same day

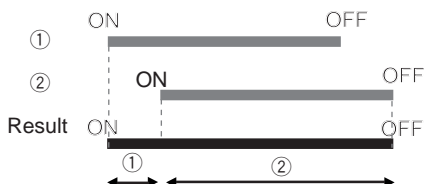

When the ON and OFF times overlap, the player operates as indicated in the following examples.

Example 5:

In ①, the player begins to operate according to the time set for ON. Next, in ② the player ignores the second ON time and continues to play. The OFF setting for ① is also ignored thus the player turns OFF at the time set for ②.

Example 6:

When the following settings are selected for the same day

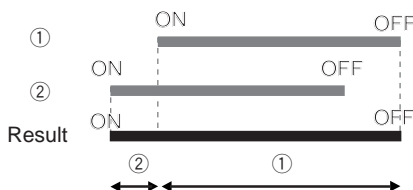

Example 6:

In ②, the player begins to operate according to the time set for ON. Next, in ① the player ignores the later ON setting and continues to play. In this case, the OFF setting for ② is skipped thus the player turns OFF at the time set for ①.

Example 7:

When the following settings are selected for the same day

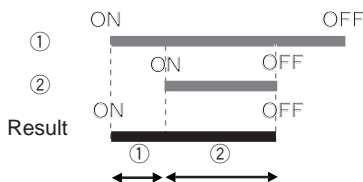

Example 7:

In ①, the player begins to operate according to the time set for ON. Next, the player continues to play past ②'s ON time. The power to the player then turns OFF at the ending time set for ②.

Example 8:

When the following settings are selected for the same day.

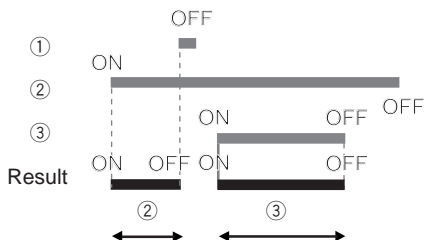

Example 8:

In ②, the player operates according to the time set for ON. Next, in ① the player turns OFF briefly according to the time set for OFF. Then, in ③ the player begins again at the time set for ON. Lastly, the player turns OFF at the time set for ③.

Example 9:

When the following settings are selected for ALL and SUN (① ON and ② OFF are the same time)

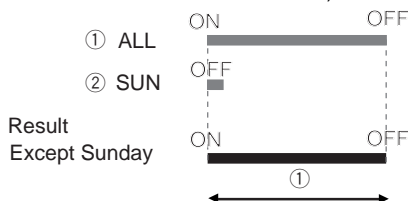

Example 9:

In ① ALL (every day), the player powers ON according to the time set for ON, except for Sunday. These settings turn the player ON and OFF according to the times set for the first series in ①. The player therefore stays OFF on Sunday.

Notes

When the ON and OFF times are set to the same exact time, the player reacts differently according to any previously designated settings.

In Example 9, when the ON and OFF times are identical, the power is OFF and the player is in Standby until the proper time reached.

When the ON and OFF times are identical, if the player is already ON, the OFF setting on the second timed series, ②, is ignored.

Power On Start Function

DVD Video CD CD

1-2

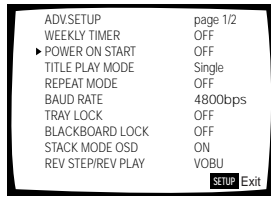

3

In the case of 1
In the case of 2
In the case of 3

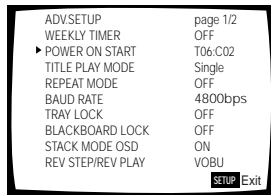
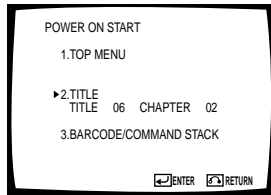

Selecting the special Title and Chapter

- Select ENTER on the screen to save the setting and exit the screen. Select RETURN to cancel the setting and return to the previous screen.

Setting the Power On Start Function

1. Move the ► (pointer) to "POWER ON START" by pressing or .
2. Set it to ON using the or buttons
3. Press .

- The POWER ON START option screen is displayed

1.TOP MENU:

Playing from the top menu screen

2.TITLE:

Playing the specified Title and Chapter

3.BARCODE/COMMAND STACK:

Recalling and executing the Barcode/Command Stack groups in memory

- Select one of the above with or and press .

1. Playing the top menu

- Move the ► (pointer) to 1. TOP MENU and press .

2. Playing the specified Title and Chapter

- Move the ► (pointer) to 2. TITLE and press .

Example: To begin playback with Chapter 2 of Title 6

A: Press → → → → →

B: Press or to select 06 and press to start setting the next set of figures. Press either the or to select 02 and press .

NOTE

- When playing CDs/Video CDs, the player ignores the Title entry and sees the Chapter as a track number. Barcode Commands are valid for CD Barcodes only*.

You can set the POWER ON START function with the mouse as well as with the remote control.

- Where is displayed, click with the left mouse button to change selections or settings.
- Clicking on a number with the left mouse button increases the number by 1. Each time you click on a number with the right mouse button, it decreases by 1.

* Barcode Commands designed for CDs are acceptable. However, Barcode Command Stacks are unavailable for CDs and Video CDs. DVD Barcode Commands and Stack Groups function properly on the DVD-V7400.

Power On Start Function

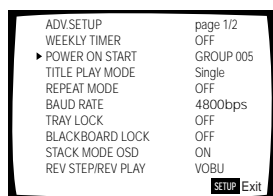
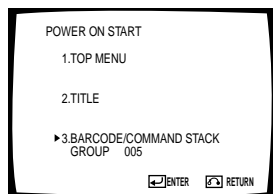

Setting a Barcode/Command Stack Group

- Select ENTER on the screen to save the setting and exit the screen. Select RETURN to cancel the setting and return to the previous screen.

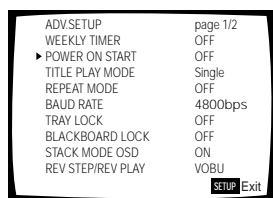

For your reference

Memorized data is retained even if the power cord is unplugged.

3. Recalling and Executing Barcode/Command Stack Groups from Memory

- Move the ► (pointer) to 3. BARCODE/COMMAND STACK and press

Example: To execute Barcode/Command Stack Group 5

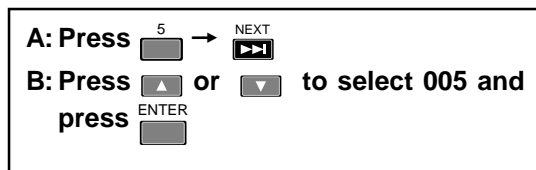

- The ADV SETUP menu screen displays again, showing the POWER ON START setting. When this setting is displayed, the operation is complete.

NOTE

Discs authored to begin playing automatically may fail to play back as programmed on this menu.

DVD Video CD CD

Setting to Turn ON Player Power Only

Select a Title which is not on the disc.

Example: Enter title 99

DVD Video CD CD

Turning Off the POWER ON START Function

- 1 On the ADV SETUP menu screen, move the ► (pointer) to POWER ON START with the remote control arrow or and select OFF with the remote control arrow or .

It is possible to use a mouse instead of the remote control. When the ► pointer is on MENU, click the left button to have the ADV. SETUP menu disappear.

Barcode/Command Stack Function

To use the Barcode Stack/ Command Stack function:

- Player memorizes commands from the barcode book (barcode book included with the disc)
- Commands may be sent from the Remote Control if barcodes are unavailable from the disc (Command Stack function)
- Use the remote control to recall and successively execute, or execute commands step by step, from memorized content

NOTE:

In the case of laser barcode compatible discs, barcodes designed for industrial LD use are acceptable (verify that such discs include the LB₂ mark). Using an LB barcode sheet for LB₂-unmarked discs is unavailable.

NOTE:

The Barcode Stack/Command Stack function fails to operate with CDs and Video CDs.

NOTE:

- The player is able to memorize a maximum of 300 steps including video blackboards.
- Memorized data is retained even if power to the unit is switched OFF.

DVD

Basic Usage

Use the Barcode Stack/Command Stack function as follows: (for setting details, refer to the pages after the right arrow)

- 1 **Display the Barcode Stack/Command Stack setup screen with the remote control** → Page 54
- 2 **Input the barcode with the barcode reader and transmit to the player** → Page 55
 - An alternate input source is the remote control
For LaserBarcode compatible discs → page 59
For standard DVD discs → Page 54-58
- 3 **Repeat step 2 in the desired playback order**
- 4 **Store the command input to the player's memory** → Page 60
- 5 **Execution** → Page 69, 70

DVD

Advanced Usage

With the Barcode Stack/Command Stack function, groups can be divided and memorized without affecting previously stored commands.

This is convenient for separate memorization of contents on more than one disc, or when many users share one player.

This also allows separate storage of a group with previously memorized content.

1 Register a new group → Page 62

"GROUP 002" on the top right of the Barcode Stack/Command Stack input screen is the number assigned to the new group.

The group number is important for execution, please make note of this number for future reference.

2 Input the barcode with the barcode reader and transmit to the player → Page 55

- The remote control may also input commands
In the case of laser barcode compatible discs
→ Page 59

In the case of regular DVD discs → Page 54-58

3 Repeat step 2 for each barcode to play in that specific order

4 WStore the sequence in the DVD-V7400's memory → Page 60

5 Execution → Page 69, 70

Select the group number that was noted in step 1

NOTE:

Commands stored in the player's memory are grouped together or divided → Page 65-68

Once a group of commands are stored in the the player's memory, the play order is locked. Changes are prohibited.

Barcode/Command Stack Setting

The player can store commands input using LaserBarcode and DVD barcodes. The stored commands can be recalled for either successive or step-by-step execution.

Memorized data is retained even if the AC power cord is unplugged.

DVD

Displaying the Barcode/Command Stack Screen

1

Barcode/Command screen

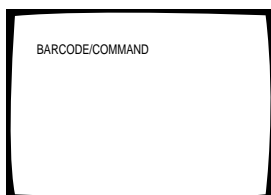

2

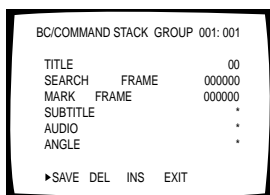
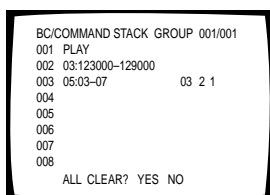

1 Press ^{MEMORY}

- "BARCODE/COMMAND" displays

NOTE

The player ignores this command while the Player Control Panel is displayed.

2 Press ^{ENTER}

- The Barcode/Command Stack screen is displayed.
- If barcodes have already been input, the data is shown on the screen.
Select whether barcodes are input by erasing existing barcodes or by adding to the existing barcodes
- To input new barcodes from the beginning, select "YES" with or and press ^{ENTER}
- To add new barcodes to existing barcodes, select "NO" with or and press ^{ENTER}
- Press ^{ENTER} to display the Barcode/Command Stack input screen.
- If no barcodes have been input, the Barcode/Command Stack input screen is displayed.

- The setting procedure of this screen is described in the subsequent pages.
- Barcode/Command Stacks can be set directly using a barcode reader (optional) or with the remote control.

1

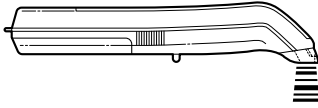

2

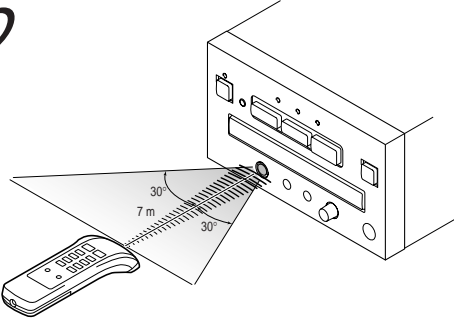

DVD

Direct Setting Using a Barcode Reader

- 1 Read a barcode with a barcode reader.
- 2 Send it to the player.

Example 1: Read "PLAY" then send it
 Example 2: Read "Play Title 8 Chapters 5 to 12 with Subtitle 3, Audio 2 and Angle 1" then send it.

DVD

Setting Using the Remote Control

Set the commands, Play ►, Pause ■, ◀■ Still/Step ■▶ and Stop ■ and WAIT and GO TO GROUP using the remote control.

The Chapter Search, Chapter Play, Frame Search and Frame Segment Play* commands can also be set using the remote control.

* Frame Segment Play is to play between two specific frames.

Press  TITLE/CHP FRM/TIME

- The TITLE number blinks and the input mode is selected



Example 1: To set "Play"

Press  PLAY

- The Barcode/Command Stack Input screen shows "PLAY" and advances to the next Input screen.



Example 2: Enter the wait time

1. Press and hold  PAUSE

- "WAIT 000 sec" appears on the screen
- 2. Use the number buttons to enter the wait time in seconds.
- The maximum time value is 999

3. Press  NEXT

(completes the process)

Barcode/Command Stack Setting

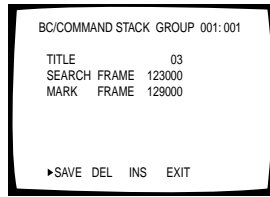

Display shown when the example on the right is input

Note

A Barcode/Command Stack entry must be 25 frames or greater in length for the command to function. The player refuses commands which set fewer frames.

Example 3: To "Play Title 3 Frames 123000 to 129000"

1. Press ^{TITLE/CHP} ^{FRM/TIME}
 - The TITLE number blinks
2. Press 3 →
 - Title 3 is set, and the mode switches to Frame Input
3. Press 1 → 2 → 3 → 0 → 0
 → 0 →
 - Sets the starting frame number
 - If this operation occurs during playback, the player searches to the input frame immediately.
4. Press 1 → 2 → 9 → 0 → 0
 → 0 →
 - Sets the ending frame number
 - If the above operation is performed during playback, press the remote button ^{ENTER} in place of specifying the frame number in steps 3 and 4. This action automatically sets the frame being played as the ending frame.

Example 4: To "Play Title 5 Chapters 3 to 7 with Subtitle 3, Audio 2 and Angle 1"

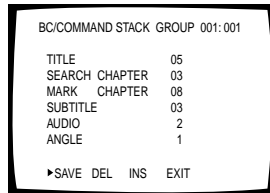

Display shown when the example on the right is input

1. Press ^{TITLE/CHP} ^{FRM/TIME}
 - The TITLE number blinks
2. Press 5 →
 - Sets Title 5 and prepares for Chapter input
3. Press ^{TITLE/CHP} ^{FRM/TIME} to select **SEARCH CHAPTER**
 - Sets the Chapter number where playback starts
 - Each press toggles the selection between "FRAME" and "CHAPTER"
4. Press 3 →
 - Sets the starting Chapter number
5. Press 8 →
 - Sets the ending Chapter number
6. Press 3 →
 - Sets Subtitle 3
7. Press 2 (do not press)
 - Sets Audio 2
8. Press 1 (do not press)
 - Sets Angle 1 - advance to the next step

For Reference

To play to the end of chapter 7 as shown in Example 4, enter "8", (Chapter 7 + 1 additional Chapter) in MARK CHAPTER.

Item display

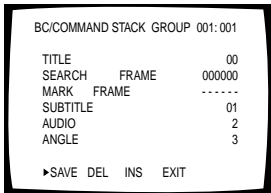





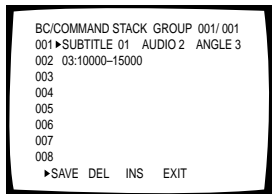

Press  to display the following screen

List display



Example 5: To input the command for setting Subtitle 1, Audio 2 and Angle 3

1. When the word TITLE is blinking, enter "00" in the TITLE field
 - Do NOT press 
2. Press  while the TITLE digits are blinking
3. When the SUBTITLE digits start to blink, press  then 
4. When the AUDIO digit starts to blink, press 
5. When the ANGLE digital starts to blink, press 

• A Play command that specifies the start and end frames, voids any possibility of setting a Subtitle, Audio and Angle option. However, by setting Subtitle, Audio and Angle selections (as described in the above procedure) before the Frame Section Play command, the playback includes these options.

The input as shown above plays Title 3 Frames 10000 to 15000 with Subtitle 1, Audio 2 and Angle 3.

Commands other than Frame Section Play command, such as Fame Search, Chapter Search and Chapter Section Play commands, a specific setting is valid within each command.

1.

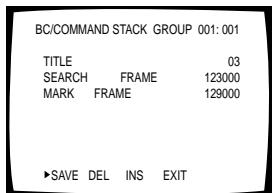

2.

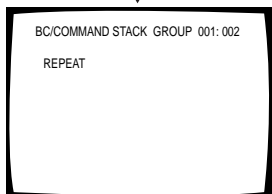
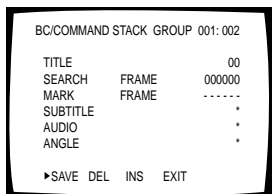

Example 6: To repeat "Play Title 3 frames 123000 to 129000" in Example 3

1. Perform steps 1 through 4 in Example 3
 - The Barcode/Command Stack input screen appears
2. Press  while the TITLE number is blinking
 - The REPEAT indicator appears on screen

Barcode/Command Stack Setting

Example 7: a command to jump to another group

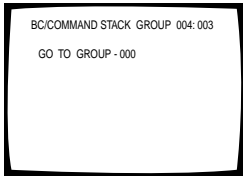

1. When the TITLE number is flashing, press **RECALL**.
2. The display changes as shown to the left (refer to diagram).
3. Input the group number to jump to, then press **NEXT**.

To change the group number on a previously input "GO TO GROUP", press **RECALL** during Detailed or List display, and input the new number.

Using this command enables consecutive jumps to different groups.

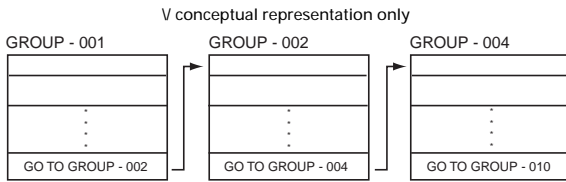

Create standby display groups to return to the same point as before a jump to another group.

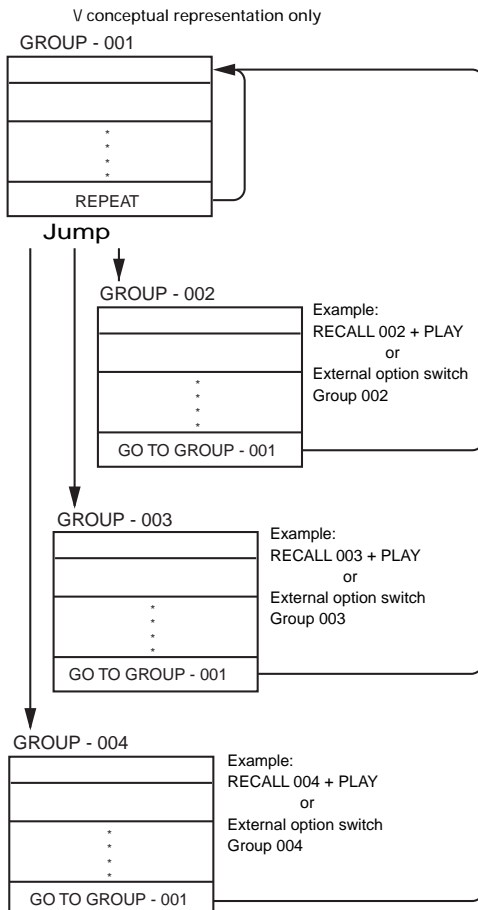

DVD

Setting the Subtitle, Audio and Angle

SUBTITLE

- "00" changes screen color to the selected "Background color" in the GUI menu and makes a played image invisible
- "01" to "32" displays the corresponding Subtitle
- "33" plays with all Subtitles off
- "34" hides the played image with "00" to reveal the played image again
- "99" retains the previous condition. This is used to change settings other than SUBTITLE while maintaining the current Subtitle setting
- "35" to "98" are invalid settings

AUDIO

- "0" plays image with Audio off
- "1" to "8" selects and plays the corresponding audio
- "9" retains the previous condition

ANGLE

- "1" to "8" selects and plays the corresponding angle
- "9" retains the previous condition
- "0" selects and plays Angle 9

NOTE

- When "retain the previous condition" is selected, an asterisk (*) appears on the input screen.
- The Barcode/Command Stack cannot be executed if a value unavailable on that disc is input.

DVD

To Only Use A Chapter Search or Frame Search

In item "MARK CHAPTER" or "MARK FRAME", press

NEXT **▶▶** without making any settings

A still image displays after the search is complete

DVD

To Change a Value During Input

Press the correct number button (including 0)

To return to a previous setting point, press **PREV** **◀◀**.

DVD

Cancel a Value During Input

Move the **▶** (pointer) to "EXIT" by pressing the cursor button

▶ (right direction) and press **ENTER** **◻**.

Setting of LaserBarcode-Compatible Discs

BC/COMMAND STACK GROUP 001:001			
TITLE		LD	
SEARCH	FRAME	01500	
MARK	FRAME	01800	
VIDEO		0	
AUDIO		3	

Example screen

NOTE:

Pressing  after step 2 selects Chapter input mode.

See page 56 for SEARCH CHAPTER and MARK CHAPTER input methods.

NOTE:

When "Maintaining Previous Mode" is selected, an "*" appears on the input screen.

Example: Playback of "analog stereo" audio channel from frame 1500 to 1800 but without video

1. Press



- The TITLE number blinks

2. Press to display LD

- Verify that the LaserBarcode-compatible command is set to TITLE LD display.

3. Press



- Enter the Starting Frame number
- If this command is sent while a disc is playing, the Search begins for the Start Frame.

4. Press



- Enter the Ending Frame number

5. As the VIDEO number begins to blink,

press 

- The image on screen disappears

6. As the AUDIO number begins to blink,

press 

- Audio is entered and the screen advances to the next step

Video, Audio Setup

VIDEO:

- Inputting 1 selects normal video output
- Inputting 0 selects the background color set on the GUI menu and cancels the playback
- Inputting 9 maintains the previous mode (this setting leaves the VIDEO at the current selection)

- 2 to 8 are invalid

AUDIO:

On LaserBarcode-compatible discs, laser disc digital audio and analog audio are converted and recorded in the DVD format.

Audio Selections:

- Inputting 0 selects Audio OFF
- Inputting 1 selects Analog Audio 1/L
- Inputting 2 selects Analog Audio 2/R
- Inputting 3 selects Analog Audio Stereo
- Inputting 5 selects Digital Audio 1/L
- Inputting 6 selects Digital Audio 2/R
- Inputting 7 selects Digital Audio Stereo
- Inputting 9 maintains the previous mode
- 4 and 8 are invalid

Barcode/Command Stack Setting

DVD

Saving A Barcode/Command Stack

After inputting the example, the Barcode Stack/Command Stack input screen appears.

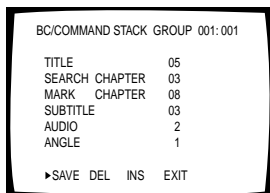

When this screen appears, press or to move (pointer) to SAVE and press

- The display disappears and the information is saved

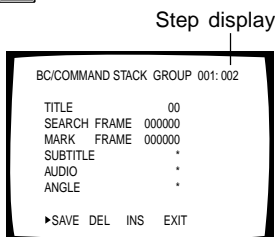

NOTES:

- The input information is NOT saved if the (pointer) is on SAVE and is pressed BEFORE the Barcode Stack/Command Stack input screen reappears for the next step.
- The input information is NOT saved if (pointer) is on EXIT and is pressed.

DVD

To Delete a Previously Input Barcode Stack/Command Stack

1 Press

- "BARCODE/COMMAND" is displayed

2 Press

- The Barcode/Command Stack screen is displayed

3 Select NO with or and press

- The Barcode/Command Stack Input screen is displayed when is pressed

4 Press

- The list appears

5 Move the (pointer) to DEL by pressing the cursor button (right direction)

6 Select the step to be deleted by pressing or

7 Press

- The selected step is deleted and the subsequent steps are moved up the list by one.

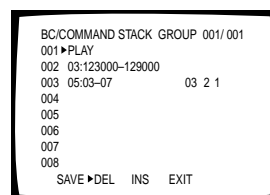

8 Move the (pointer) to SAVE by pressing and press

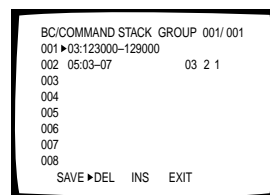











IMPORTANT:

A deletion may be cancelled any time before hitting SAVE. To abort a deletion, move the (pointer) to EXIT, press the right direction button repeatedly then simply press the unit's button. The deletion is entered in to memory only when the operation is saved at step 8.

DVD

Correcting a Previously Input Barcode Stack/Command Stack

Example: To change the Audio setting of step 003 from Audio 2 to Audio 1

- 1 Press 
 - "BARCODE/COMMAND" is displayed
- 2 Press 
 - Barcode/Command Stack screen displays
- 3 Select NO with  or  and press 
 - Barcode/Command Stack Input screen displays when  is pressed
- 4 Press 
 - List appears
- 5 Select 003  by pressing  or 
- 6 Press 
 - Initiates the Barcode/Command Stack input mode

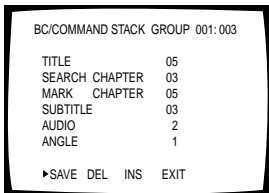

- 7 Press  4 times to select AUDIO

- 8 Press 

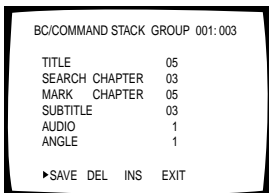



- 9 Press 
 - Next Barcode/Command Input screen displays



- 10 Move the  (pointer) to SAVE by pressing  then press 

NOTE:

To save the corrected information, press  repeatedly until the last item flashes (ANGLE in this example).







Press  again to move to the next input page.

In this "next step", move  (pointer) to SAVE and press  (to save the data).

The corrected information is NOT saved if  (pointer) is on SAVE then  is pressed before the end of correction (in the middle of the step being corrected).

DVD

Adding a Step in a Previously Input Barcode Stack/Command Stack

- 1 Perform steps 1 through 4 of "Correcting a Previously input Barcode/Command Stack".
- 2 Select the location for the new step by simply pressing the  or  button.
- 3 Move the  (pointer) to INS by pressing  or  then the  button.
 - Inserts a new step before the selected step and the subsequent steps are moved down the list by one.

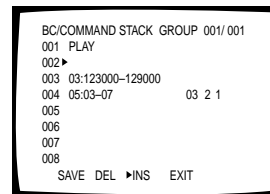

- 4 Press 
 - Initiates the Barcode/Command Stack input mode

- 5 Set a step identical to the "Barcode Stack/Command Stack settings" (see page 55- 59).

- 6 Move the  (pointer) to SAVE by pressing  then the  button.

Grouping Some Barcode/Command Stacks

1

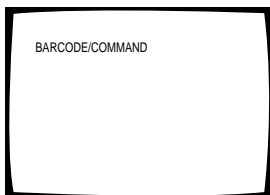

2

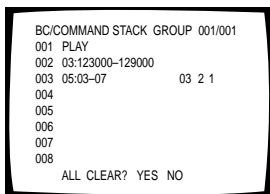

3

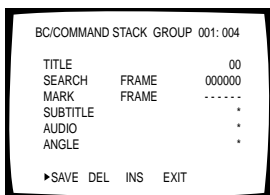

4

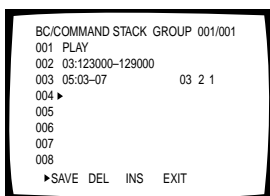

5

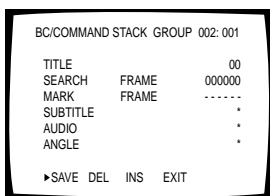

DVD

Methods of Grouping

Grouping Some Barcode/Command Stacks

A group can be formed with several Barcode/Command Stacks, more than one group can be formed and stored. To execute a group of commands, select a group from the stored groups and execute them either consecutively or step-by-step. It is also possible to divide or delete a group.

The following procedure consists of inserting a group delimiter after a group of barcode commands.

Inserting a Group

1 Press **MEMORY**

- "BARCODE/COMMAND" is displayed

2 Press **ENTER**

- Barcode/Command Stack screen displays

3 Select **NO** with **◀** or **▶** then press the **ENTER** button

- Barcode/Command Stack Input screen displays when the **ENTER** button is pressed

4 Press **DISPLAY**

- List appears
- Verify that the ▶ (pointer) is located at the step immediately following the last entry

5 Press **NEXT**

- The input screen for the first step of the next Barcode/Command Stack group appears
- Set the next group for the Barcode/Command Stacks

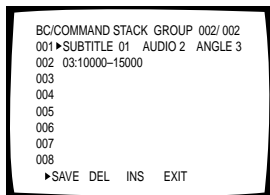
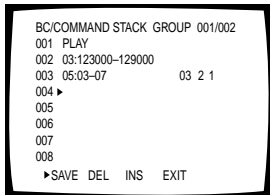

DVD

Switching the Barcode Stack/ Command Stack Group

- 1 Press **MEMORY**
 - "BARCODE/COMMAND" is displayed
- 2 Press **ENTER**
 - Barcode/Command Stack screen displays
- 3 Select **NO** with **◀** or **▶** then press the **ENTER** button.
 - The Barcode Input screen displays as soon as the button is pressed
- 4 Press **DISPLAY**
 - List appears
- 5 Press **PREV / NEXT**
 - Pressing **NEXT** switches the view to the next group
 - Pressing **PREV** switches the view to the previous group

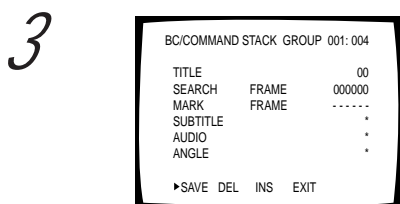
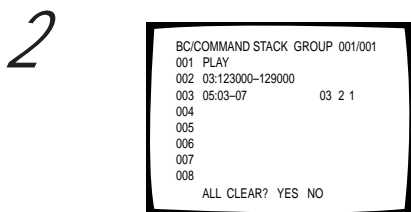
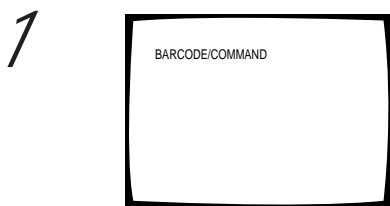

DVD

Deleting a Group

- 1 Press **MEMORY**
 - "BARCODE/COMMAND" is displayed
- 2 Press **ENTER**
 - The Barcode/Command Stack screen displays
- 3 Select **NO** with **◀** or **▶** and press **ENTER**
 - Barcode Stack Input screen displays when **ENTER** is pressed

Grouping Some Barcode/Command Stacks



4

```
BC/COMMAND STACK GROUP 001/001
001 PLAY
002 03:123000-129000
003 05:03-07 03 2 1
004 ▶
005
006
007
008
▶SAVE DEL INS EXIT
```

4 Press ^{DISPLAY} 
• List appears

5

```
BC/COMMAND STACK GROUP 001/001
001▶PLAY
002 03:123000-129000
003 05:03-07 03 2 1
004
005
006
007
008
▶SAVE DEL INS EXIT
```

5 Select the group to be deleted by pressing
^{PREV}  / ^{NEXT} 

6

```
BC/COMMAND STACK▶GROUP 001/001
001▶PLAY
002 03:123000-129000
003 05:03-07 03 2 1
004
005
006
007
008
▶SAVE DEL INS EXIT
```

6 Move the ▶ (pointer) to “GROUP” on the first line by pressing 

7-8



```
BC/COMMAND STACK GROUP 001/001
001▶
002
003
004
005
006
007
008
SAVE▶DEL INS EXIT
```

7 Move the ▶ (pointer) to DEL by pressing the right button  (right direction)



8 Press ^{ENTER} 
• Deletes the selected group

9

```
BC/COMMAND STACK GROUP 001/001
001▶
002
003
004
005
006
007
008
▶SAVE DEL INS EXIT
```

9 Move the ▶ (pointer) to SAVE by pressing the right button  then pressing the ^{ENTER}  button

IMPORTANT

A deletion may be cancelled any time before hitting SAVE. To abort a deletion, move the ▶ (pointer) to EXIT, press the right direction button repeatedly  then simply press the unit's ^{ENTER}  button. The group is deleted from memory only when the operation is saved at step 9.

DVD**Dividing a Previously Input Group**

1

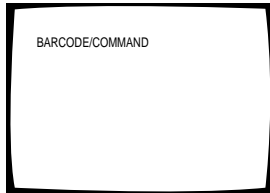
1 Press ^{DISPLAY}

- "BARCODE/COMMAND" is displayed

2

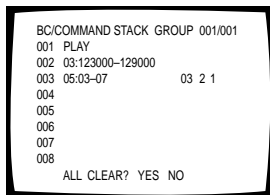
2 Press ^{ENTER}

- Barcode/Command Stack screen displays

3

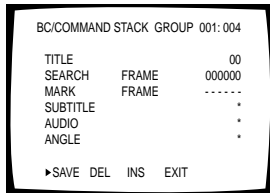
3 Select **NO** with or and press ^{ENTER}

- The Barcode/Command Stack Input screen displays when ^{ENTER} is pressed

4

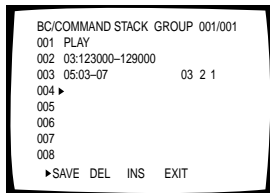
4 Press ^{DISPLAY}

- List appears

5

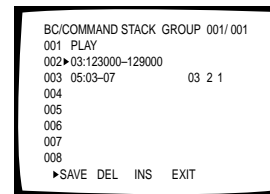

5 Select the step where the group is to be divided/split by pressing or

- Move the ▶ (pointer) to what will be the first step of the new group

Grouping some Barcode/Command Stacks

6

```
BC/COMMAND STACK GROUP 001/001
001 PLAY
002▶03:123000-129000
003 05:03-07      03 2 1
004
005
006
007
008
SAVE DEL ▶INS EXIT
```

6 Move the ▶ (pointer) to INS by pressing



7

```
BC/COMMAND STACK GROUP 001/001
001 PLAY
002▶
003 03:123000-129000
004 05:03-07      03 2 1
005
006
007
008
SAVE DEL ▶INS EXIT
```

7 Press 

- Inserts a step before the selected step and moves all other steps down by one

8

```
BC/COMMAND STACK GROUP 002:001
TITLE                                03
SEARCH  FRAME  123000
MARK    FRAME  129000
SAVE DEL ▶INS EXIT
```

8 Press 

- To divide the existing group at the vacant step
- Displays the Barcode/Command Stack input screen at the first step of the newly created group



9

```
BC/COMMAND STACK GROUP 002:001
TITLE                                03
SEARCH  FRAME  123000
MARK    FRAME  129000
▶SAVE DEL INS EXIT
```

9 Move the pointer to SAVE by pressing the



IMPORTANT

A division may be cancelled at any time before hitting SAVE. To abort a division, move the ▶ (pointer) to Exit, press the left direction button  then press the  button. The division is only entered in to memory when the operation is saved at step 9.

DVD**Merging Two Barcode Stack/
Command Stack Groups**

1

1 Press ^{MEMORY}

- "BARCODE/COMMAND" is displayed

2

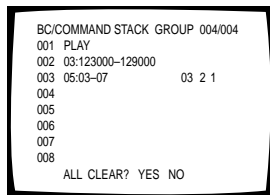
2 Press ^{ENTER}

- Barcode/Command Stack screen displays

3

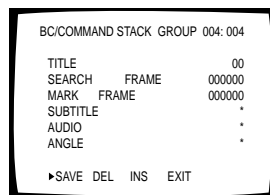
3 Select **NO** with or and press ^{ENTER}

- The Barcode/Command Stack Input screen displays when ^{ENTER} is pressed

4

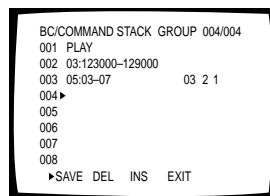
4 Press ^{DISPLAY}

- Displays the list of the last group that was input

5

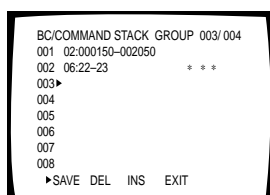
5 Change the group with ^{PREV}

- Move the ▶ (pointer) to the next step of the previously input number with or becomes the division point)

Grouping some Barcode/Command Stacks

6

```
BC/COMMAND STACK GROUP 003/004
001 02:000150-002050
002 06:22-23      * * *
003▶
004
005
006
007
008
SAVE▶DEL  INS  EXIT
```

6 Move the ▶ (pointer) to DEL by pressing the right button  (right direction)

7



```
BC/COMMAND STACK GROUP 003/003
001 02:000150-002050
002 06:22-23      * * *
003▶PLAY
004 03:123000-129000
005 05:03-07      03 2 1
006
007
008
SAVE▶DEL  INS  EXIT
```

7 Press  **ENTER**



- Deletes the group delimiter and joins the current group with the next group from the memory
- Group numbers in memory are advanced by one

8

```
BC/COMMAND STACK GROUP 003/003
001 02:000150-002050
002 06:22-23      * * *
003▶PLAY
004 03:123000-129000
005 05:03-07      03 2 1
006
007
008
▶SAVE DEL  INS  EXIT
```

8 Move the ▶ (pointer) to SAVE by pressing the right button  then by pressing the  **ENTER** button.

IMPORTANT

A merging may be cancelled any time before hitting SAVE. To abort a merge, move the ▶ (pointer) to EXIT by pressing the right button repeatedly , then simply press Enter or the  button. The merge is entered in to memory only when the operation is saved at step 8.

Using Barcode/Command Stacks

DVD

Recalling/Executing Bbarcode Commands From Memory

Switching the command group

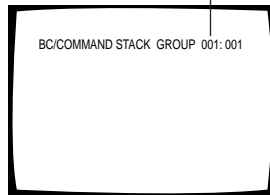

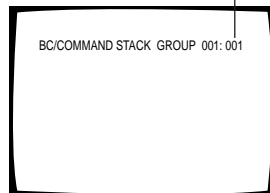

Recall screen

Switching the command step







Recall screen





To execute a barcode command group:
(verify that the disc is loaded)

- 1 Press 
- 2 Press 
- 3 Input the Command Group number using the numeric buttons.
- 4 Press  twice
 - To recall and execute the selected group

To execute steps in a command group:
(disc must be loaded to execute steps)

- 1 Press 
- 2 Press 
- 3 Input the Command Group number for recall/execution using the numeric buttons
- 4 Press 
 - To re-enter the group number, press 
- 5 Input the first step number to play using the numeric buttons
- 6 Press 
 - To recall and execute the steps in a selected group

NOTES:

- Pressing  loops the steps within a group
- Pressing  in place of  (in step 6), causes the steps to execute step-by-step. After one step is executed, simply press the button , to advance to the next step. Pressing  causes the previous command to execute.

NOTE

The unit cannot enter this mode while the Player Control Panel is displayed.

DVD

Recalling/Executing a Previously Input Barcode/Command Stack From the List View

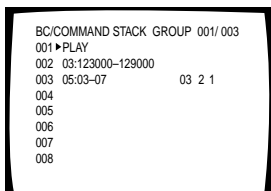

1 Press  ^{RECALL}

2 Press  ^{DISPLAY}

- Displays a list of commands



3 Select a group by pressing   ^{PREV} ^{NEXT}

- Select the command group containing the command(s) for execution

4 Select a step by pressing  / 

- Select which command step executes first. If the step number is to the left of "001" then all commands within the group are executed.

5 Press  ^{PLAY} or  ^{STEP}

- Press  for consecutive execution
- Press  for step-by-step execution

Some titles may not be available for recall and execution.

Example:

The Search command fails to execute unless a Title contains the Chapter, Time and similar information on the screen or with a disc that permits searches

Character Input/Output Drawing (DVD Video Blackboard)

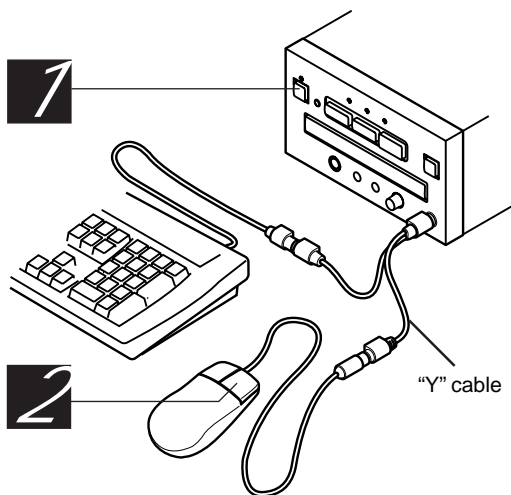

1-3

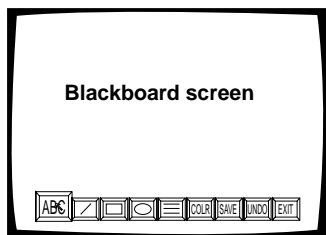

4

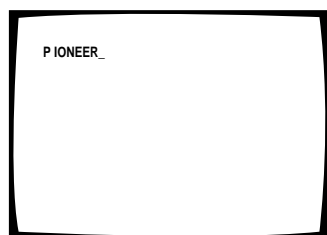

Input "PIONEER"

5

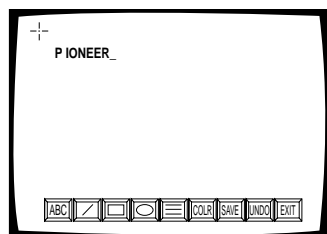

Use Video Blackboard to draw characters of pictures on the screen. The images may be displayed alone or superimposed over the video.

DVD

Operations Using the Mouse or Keyboard

Connect the PS/2 mouse or PS/2 keyboard to the mouse/keyboard connector (see page 79).

DVD

Activating the Blackboard Function

1 Turn the power ON

2 Click the right button anytime to display the Blackboard screen

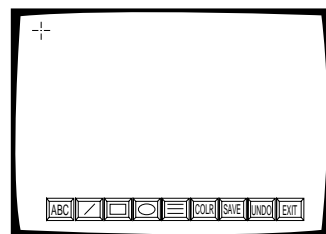
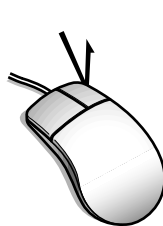

DVD

Inputting Characters

1 Move the cursor to **ABC** and click the left mouse button

2 Move the cursor to the location for the first character

- The cursor changes to a I mark in the areas where character input is possible

3 Click the left mouse button

- " _ " blinks showing that the unit is ready for input

4 Input a character

- Characters may be entered from a computer keyboard

The keyboard inputs characters by distinguishing the numerals, symbols and uppercase/lowercase alphabet bet as well as carriage returns.

5 Click the right mouse button after typing the information

- The Blackboard screen displays again
- To save the characters, refer to "Saving Characters or Pictures" on page 73

NOTE

The system cannot enter this mode while displaying the Player Control Panel

Character Input/Output Drawing (DVD Video Blackboard)

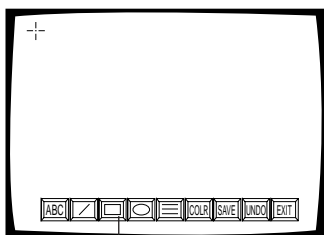

Drawing tool

1

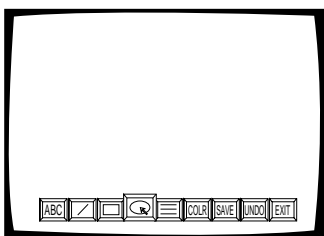

2

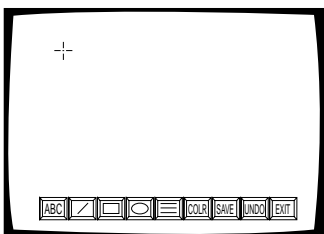

3

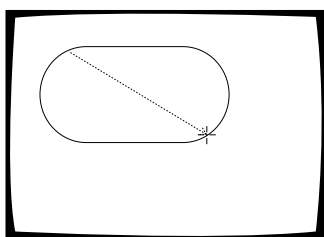



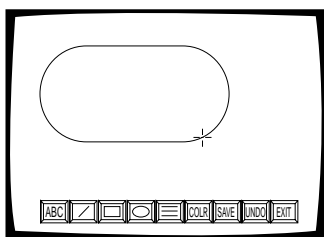









4







DVD

Using the Drawing Tools

- Use the left mouse button to select an icon

-  **(LINE):** Draws a straight line
-  **(BOX):** Tool can be switched by clicking between outline of a square/rectangle, filled/solid square/rectangle or a box (hollow) with the outside filled
 -  : Fills the inside of a box
 -  : Fills the outside of a box
-  **(ROUND):** Tool can be switched by clicking between outline of an ellipse, filled/solid ellipse or a hollow ellipse with the outside filled
 -  : Fills the inside of an ellipse
 -  : Fills the outside of an ellipse
-  : Tool can be switched by clicking to between a thin, medium or thick line
-  **(COLR):** Each click switches the color to Red, Blue, Green, Yellow, White, Black, Gray or Purple
-  **(SAVE):** Saves the drawn picture
see page 73 for the saving method
-  **(UNDO):** Cancels the drawn picture with Each click cancelling the last drawn picture
Hold the mouse button down for more than 1 second to clear the drawing from the screen
-  **(EXIT):** Click the mouse button to exit the current screen

Note

- The Direction buttons (   ) and  on the remote control can also be used for the above operation
- The Blackboard feature is unavailable on any menu screens

DVD

Drawing a Picture

Press the left mouse button at the beginning point for the drawing. Move or drag the cursor without releasing the mouse button until the image is complete.

- 1 **Select a drawing tool**
- 2 **Move the cursor to a starting position**
- 3 **Drag the cursor to the final position**
 - An image appears as the cursor moves
- 4 **Release the mouse button**
 - Repeat the above steps to draw additional images

1

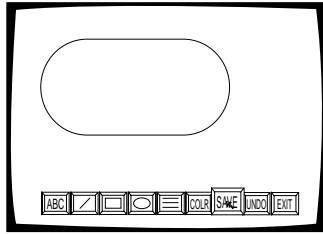

2-4

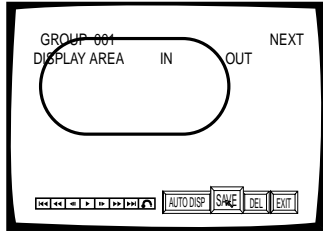

5

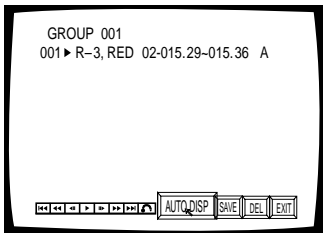

6

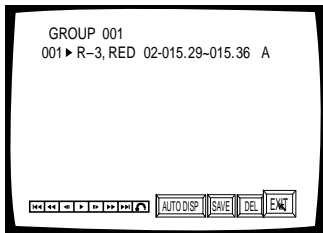

DVD

Saving Characters or Pictures

1 Click on the screen

- Save screen displays

2 Display the video which will have added objects or text

- "IN" blinks
- Use the control icon at the bottom-left of the screen to display the video

3 Click on the screen

- Display start position sets
- "OUT" blinks

4 Display the video where you want to stop displaying the object or text.

- Display the video by using the player control icon at the bottom left of the screen.

5 Click the on the screen

- Display end position sets
- Player saves images/characters to memory showing the group and step information for the entry

6 Click





- Blackboard screen displays again

NOTE:

- Save the characters and drawings to display a certain scene without playing a disc (see page 75 for details).
- Stored data is retained even if power is switched OFF.

NOTE:

- With a DVD, the start point (IN) and end point (OUT) can be set only within the same Title. The time display of the IN and OUT points is shown in () or []. In some cases the image may be slightly altered from the original.

- The Direction buttons (   ) and  button on the remote control can also control the above operation.

DVD

Details on the Blackboard

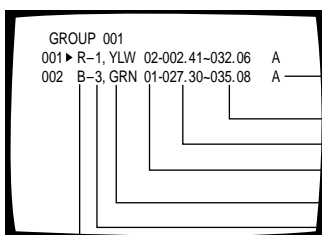

Display mode
(See next page)

Display end min.sec.
Display start min.sec.
Display title

RED : Red
BLU : Blue
GRN : Green
YLW : Yellow
WHT : White
BLK : Black
GRY : Gray
PUR : Purple

1 : Line width fine
2 : Line width medium
3 : Line width thick
i : Painted inside
o : Painted outside

L : Line
B : Box
R : Round

Character Input/Output Drawing (DVD Video Blackboard)

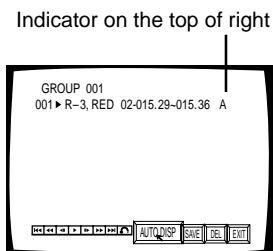

Notes

- It takes time to draw a graphical image. If the image needs to hide part of the video, the image-drawing IN point must be set in advance of the desired scene. Creation time varies according to the type of drawn graphic and to the number of drawings. The drawing time is usually in range of 10 to 30 frames.
- If different graphics are recorded in adjacent frames, they may fail to display during continuous playback because of drawing speed constraints.
- Drawings are hidden during Frame Reverse or Reverse Play.

DVD

To Change the Display Mode

1. Move the cursor to the line you want to change and click the left mouse button.
2. Move the cursor to **AUTO DISP** and click the left mouse button.

(Indicator display on the right edge of screen)

- A : Displays at the same time as the disc playback, from the set start point through the end point.
- A S : The video becomes a still image at the set start point.
- A S : The video becomes a still image immediately before the set start point.
- No display : The set characters or pictures are hidden. Pressing **ENTER** in this section reveals the drawing(s).
- S : The video becomes the still image at the set start point but objects are hidden. Press **ENTER** on the remote control to reveal or start drawing pictures.
- * : The * mark displays at the top right of the screen during playback. Pressing **ENTER** in this section starts the drawing.
- * S : The video becomes a still image, in which only the * mark is displayed, at the set start point. Press **ENTER** on the remote control to start drawing.

Meaning of Displayed Symbols

“S” stands for “Still image”; plays a still image at the IN point

“A” stands for “Auto display”; displays drawing (AUTO DISP)

“*” displays only the * mark on an empty screen

“_” displays a still image immediately before the IN point

DVD

Pencil Tool/Freehand Drawing

Click the right mouse button from within the video blackboard input screen to turn the pointer in to the pencil tool. Hold down the left mouse button to freehand draw. Clicking the right mouse button again to display the Blackboard screen.

To change the color or line width, select **COLOR** or **LINE** tool on the Blackboard screen (see “Drawing Tools” on page 72).

NOTE:

- Pictures can be drawn using the pencil tool but are later lost when the power is turned OFF.

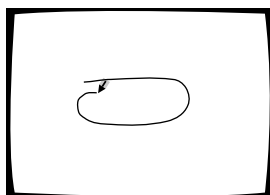
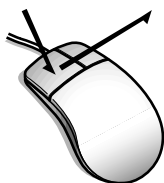

Draw by holding down the left mouse button and dragging the cursor.

Grouping Video Blackboards

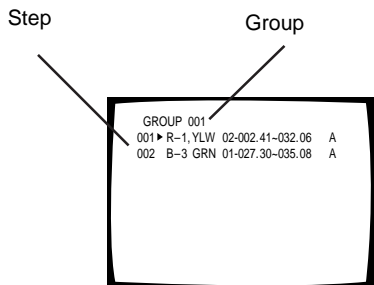

Select the group

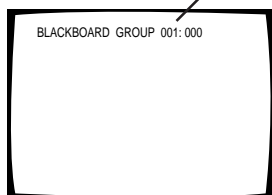

Select the step

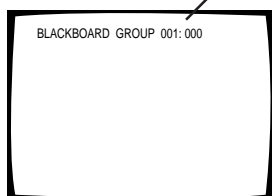

NOTE

This mode is unavailable while the player displays the Player Control Panel.

DVD

Grouping Blackboards

Divid Blackboards in to groups according to the disc and Title to register a group for later use. The drawn characters and pictures are stored to match the Title playback.

Pictures and characters comprising groups are stored as steps.

Instead of executing a blackboard, select and display a registered blackboard group. It is also possible to delete groups



Selecting a Group

When “DISPLAY AREA IN OUT” is on the screen or when the ▶ (pointer) is to the left of **GROUP**, click on the appropriate group using the **NEXT** or **PREV** mouse button.

The group can be saved/registered by clicking on icon,  from the screen.



DVD

To Select the Group

- 1 Press  twice
 - Step section blinks
 - Step section continues to display 000
 - Group executes when the step reaches 000
 - When a step is selected, only the selected step in that group executes
- 2 Press 
 - Group selection blinks
- 3 Use the numeric buttons to input a Group number
- 4 Press  twice
 - Starts execution according to the selected blackboard

DVD

To Execute Steps in a Group

- 1 Press  twice
- 2 Press  switch the group if necessary
 - Skip to Step 5 below if the group remains the same
- 3 Use the numeric buttons to input a Group number
- 4 Press 
- 5 Input the first Step number using the numeric buttons (where execution begins)
- 6 Press 
 - Execution of the selected Step in the Group begins
 - Step setup is released after the step plays

Grouping Video Blackboards

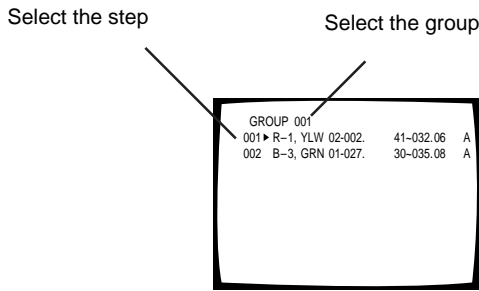

Example

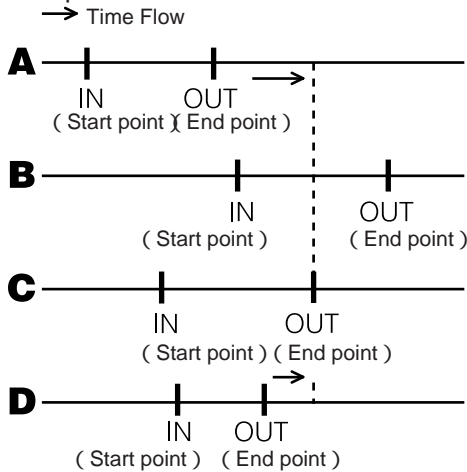

DVD

Recalling/Executing Previously Input Blackboards While Observing the List

1 Press **RECALL** twice

2 Press **DISPLAY**
 • Displays a list of commands

3 Select a group by pressing **PREV** / **NEXT**

4 Select a step by pressing **▲** / **▼**

5 Press **ENTER**

NOTE:

Press **CLEAR** to remove any displayed characters or pictures. However, characters and pictures set using the button,

AUTO DISP cannot be erased with **CLEAR**.

Display of Recalled Characters and Pictures

When recalling using the command, "Executing an entire group," images display in the order of the set start point locations rather than by register order. When a character or picture is set to display while another image is already displayed, the second character/picture superimposes on top of the existing image. All images remain on screen until the last display end point among all set display points is reached.

- When pictures A and B are displayed, picture B appears after the display of picture A has ended
- When pictures A and C are displayed, picture C appears over picture A which is already displayed with the display of pictures A and C ending at the picture C end point.
- When pictures C and D are displayed, picture D appears over picture C which is already displayed. The display of pictures C and D ends at the picture C end point.

Video Text Retrieval

DVD

This player supports playback of text files recorded on DVD Video discs.

For video text retrieval, use the mouse to click on buttons displayed during DVD Video disc playback. A button appears on screen which displays video text either on-screen with only background color or superimposed over a DVD still image.

- The Video Text Retrieval function only operates with Video Text Retrieval compatible discs. The feature is unavailable on DVDs that do not include recorded text files.
- Video Text Retrieval is a Pioneer-original format

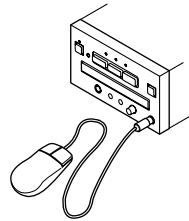
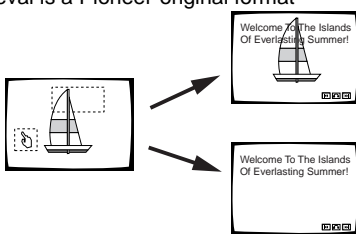

NOTE:

When returning to DVD Video playback after displaying a text file, play resumes from the starting point (the frame on-screen when the button was clicked).

External Synchronizing Function

DVD

To activate, set the EXTERNAL SYNC option under the ADV. SETUP menu to OFF, then set the disc type to either NTSC or PAL, (according to the type of disc to be played). Next, set the TV SYSTEM selector on the rear panel to NTSC or PAL to match the disc format.

Through external input of a synchronization signal (black burst), video output signals may be synchronized with external signals on the DVD-V7400 (During DVD disc playback).

Also, video switch timing can be matched to avoid picture disturbance on the TV. Devices such as aTBC (Time Base Collector) are unnecessary.

Synchronized Use of 2 or More Players

- Use a single sync generator to synchronize two or more players
- Verify that the terminator switch on the **terminal player** is ON but this switch on all other players is OFF
- Set the terminator switch to ON when synchronizing one player

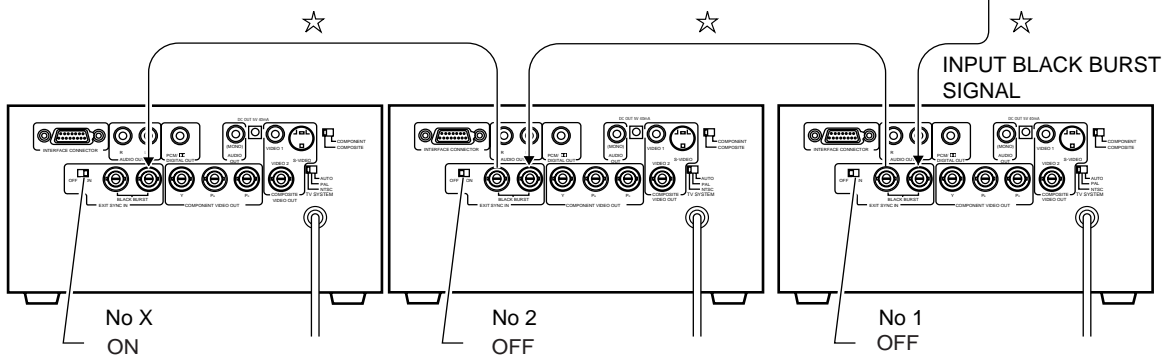
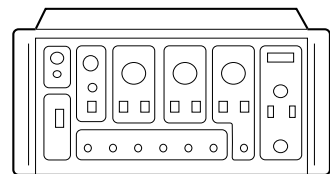

☆ Cables can be found at local audio/video dealers

NOTE:

- When the external synchronizing function is turned ON, only DVD discs can be played.
- Locking to the sub carrier element of the black burst signal fails to happen.
- During the approximately 5 seconds needed for locking to the external synchronizing signal, some video disturbance at the video output jacks is possible.
- Input the external synchronizing signal before playback of a DVD disc. Synchronization fails if input happens after playback begins.
- In cases where two or more DVD-V7400 units are externally synchronized and their videos are started simultaneously, (for frame-synchronized playback) turn OFF the AV SYNC COMPENSATE on the ADV. SETUP menu. The external sync function only works with DVD play; the function fails on any other operation.

How to Display Total Hours Played and Power ON Time

DVD Video CD CD

The DVD-V7400 displays the total play time and power ON time to provide working condition and maintenance timing information.

Refer to the directions below to display the play time and power ON time.

1 Press and hold  on the player's front panel before turning the power ON, press 

2 Verify that the screen shows the following:

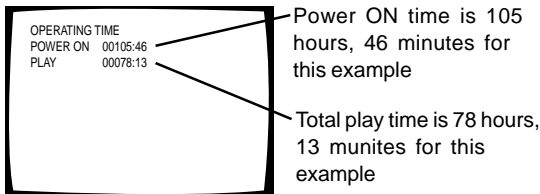

3 When performing an operation such as playback from the remote control, time information disappears as normal operation begins.

NOTE

- Because time is measured by the CPU clock, information includes an error of up to two percent.
- Changing the total play time and power ON time to zero is unavailable.

Connecting the Player

Caution: Connecting Information

The Analog copy protect technology is copy guarded. If the player is connected to a TV via a VCR, or if files are recorded/played back through a VCR, the picture may have distortions.

Video Output



Audio Output

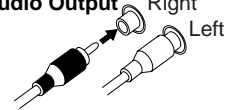

- Connect plugs to the terminals that match the plug's color (white, red, yellow).

Interface Connector (RS-232C)

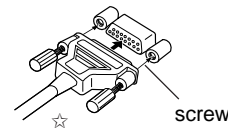

- Align the plug with the connector and insert smoothly then tighten the lock screws.

S-video Output

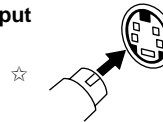

- Connect the TV's S-VIDEO terminal to the player's S-VIDEO output terminal.

External Sync Input (BNC)/Video Output (BNC)/Component Video Output (BNC)

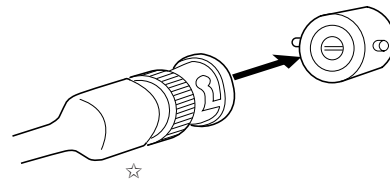

- Align the plug properly with the tab on the connector and press in carefully. Rotate the plug to the right to lock.

☆ Cables can be found at local audio/video dealers

TV SYSTEM selector

Video output changes according to the disc's recorded format.

NTSC-PAL, PAL-NTSC conversion is possible on Video CDs. PAL-NTSC conversion is unavailable on DVDs. When the TV SYSTEM selector is set to the AUTO position, the disc's format is output as is. If a CD or disc is not loaded, the previous video output setting is selected.

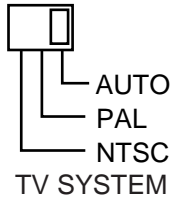

Disc		Output format		
Type	Format	Position of TV SYSTEM selector		
		NTSC	PAL	AUTO
DVD	NTSC	NTSC	MOD. PAL	NTSC
	PAL	—	PAL	PAL
Video CD	NTSC	NTSC	MOD. PAL	NTSC
	PAL	NTSC	PAL	PAL
CD, No disc		NTSC	PAL	NTSC or PAL

About MOD (Modulation) PAL

Most the newly developed countdown PAL TV systems detect 50 Hz (PAL)/60 Hz (NTSC) and automatically switch the vertical amplitude. This results in a display without vertical shrinkage. Some TV pictures may shrink vertically, leaving black bands at the top and bottom of the screen. This is not a malfunction; it is caused by the NTSC-PAL conversion. Older PAL TVs may be missing a V-Hold control, thus the picture from a NTSC disc may roll. If the TV has a V-Hold control, adjust it until the picture stop rolling.

Note: A standard TV sold in the United States is NTSC.

Connection of a Mouse and Keyboard

A commercially available PS/2 mouse or PS/2 keyboard can control the DVD-V7400 player.

- 1 Turn the power OFF to activate the standby mode.
- 2 Connect the PS/2 mouse or PS/2 keyboard to the mouse/keyboard connector.
- 3 Turn the power ON.
(connection is now complete)

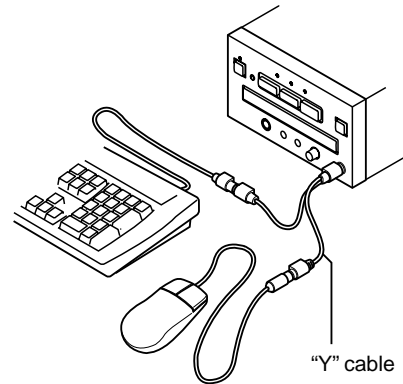

To use both the mouse and the keyboard, purchase a standard "Y" cable (available at most electronics stores).

Note:

- The power rating of this mouse/keyboard connector is no more than 5V 100mA. Avoid a mouse or keyboard with a current drain exceeding the rating of 100mA.
- Some commercially available PS/2 devices and Y cables may not be compatible with this player. For details, please consult with a Pioneer service or support center.

Connection Example 1

- Television (monitor TV)
- Control Computer
- Sync Generator

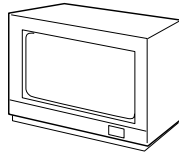

Follow these instructions to connect this player directly to a television (Monitor TV) for disc playback.

• Refer to the TV (monitor TV) manual for additional connection information.

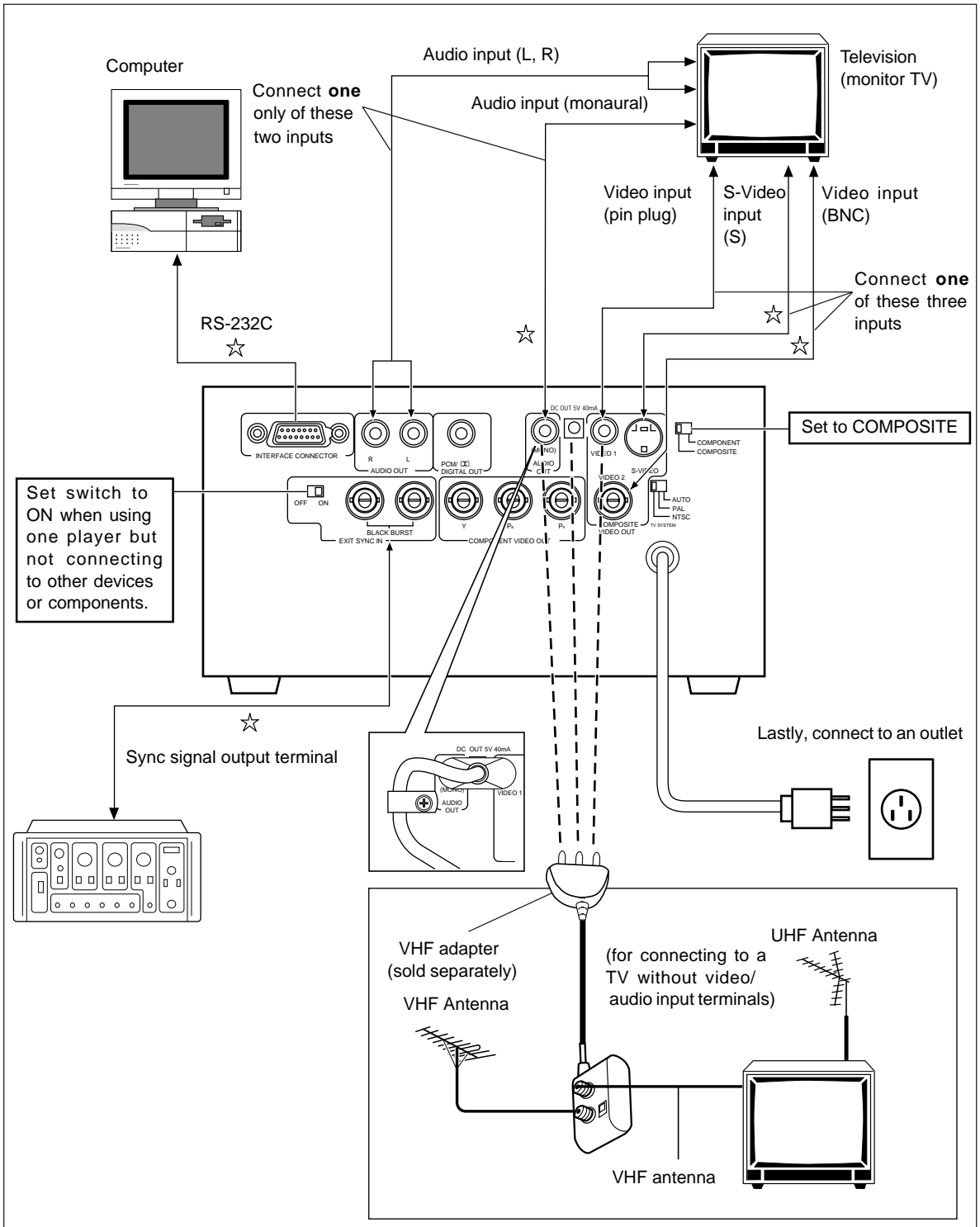

Connect to the Component Video Input

- The description of the component video input connectors may differ depending upon the TV or monitor.
- If the color of the picture is dim or off, adjust the color setting on the TV first.

Refer to the TV's owner manual for details

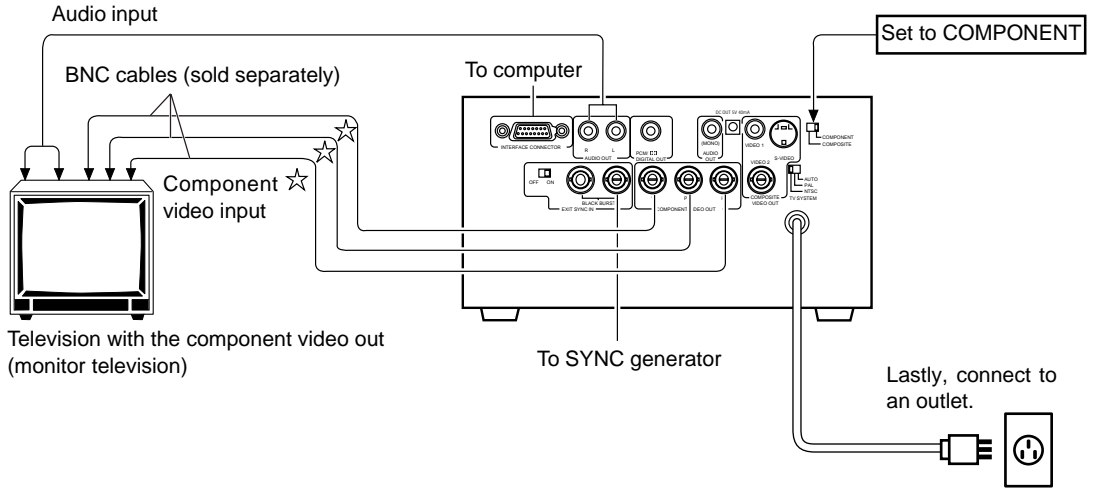

☆ Cables can be found at your local audio/video dealers

Connection Example 2

AV receiver with digital input for Dolby Digital.



For connecting the player to an amp with Dolby Digital inputs

* For use with Pioneer's VSX-27TX or VSX-29TX AV receiver

- Connect this unit's digital output PCM/  jack to the Dolby Digital input jack of a compatible amplifier.
- Select the coaxial digital output if required for the amplifier's input jack.

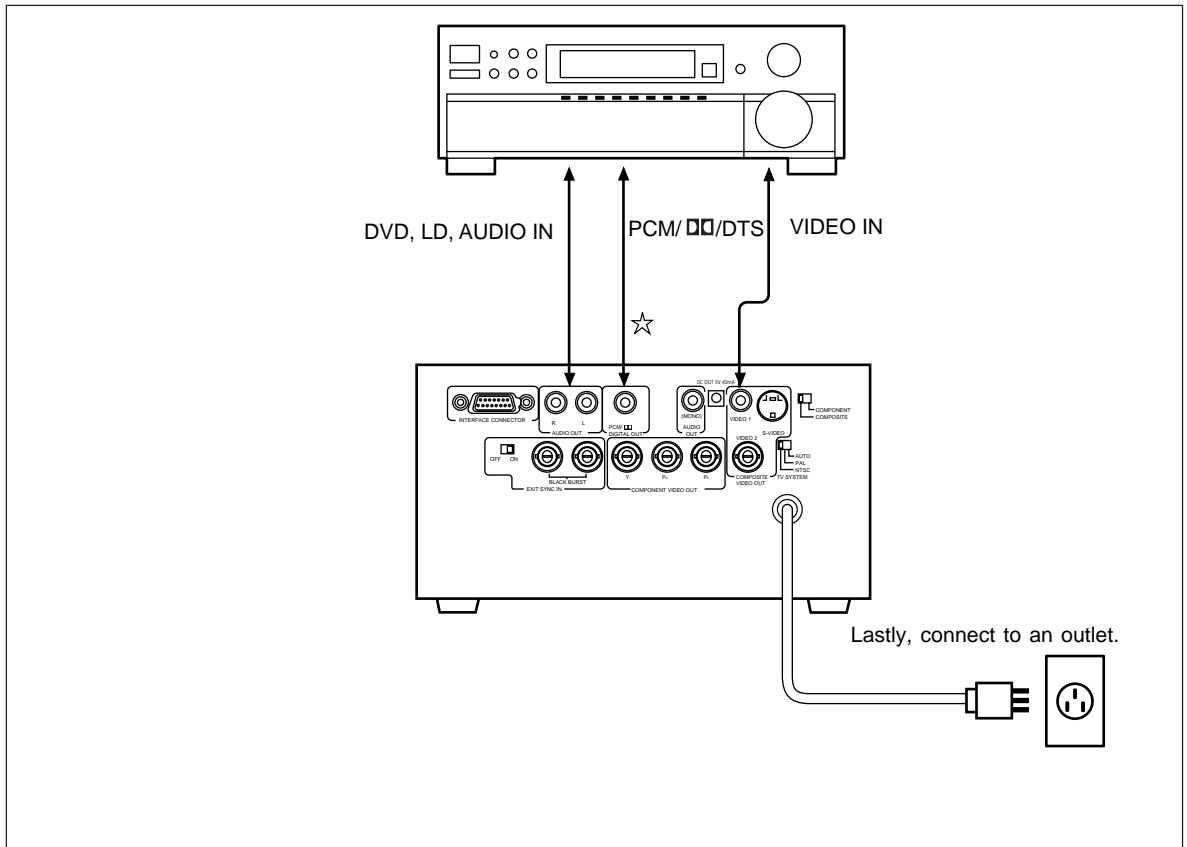

☆ Cables can be found at local audio/video dealers

- Some discs may not allow digital output when the sampling is set for 96 kHz (refer to page 35).

Connection Example 3

AV Amplifier

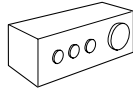

Connect to a regular AV amp or stereo amp to enjoy improved sound quality.

- Connect the player's audio output jacks to an amplifier's CD, LD, AUX or other audio input jacks except to the PHONO jacks.
- Connect the player's video output jack to the amplifier's video input jack.

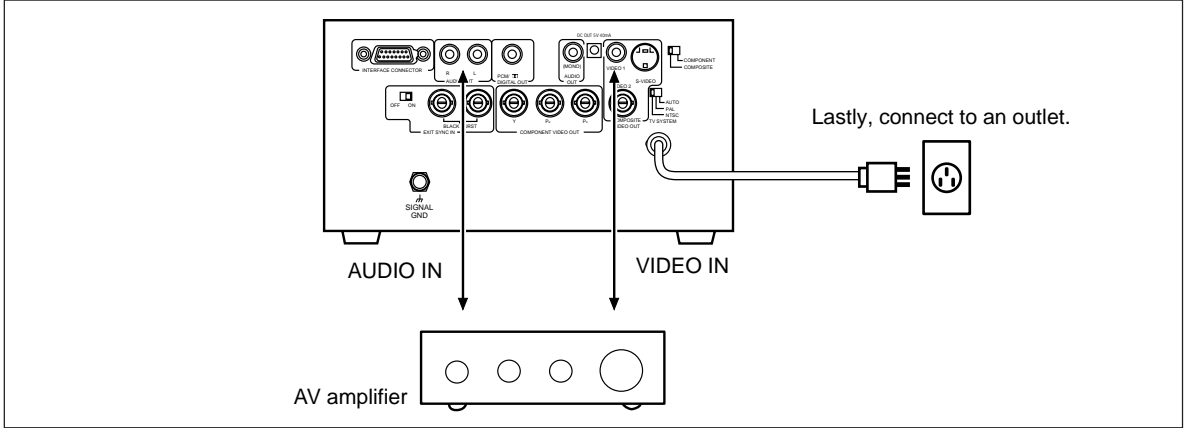

- To enjoy Surround Sound, select amplifiers that have a built-in Dolby Pro Logic decoder.
- For additional information, refer to the amplifier's owners manual.

Connection Example 4

Digital Audio recorder

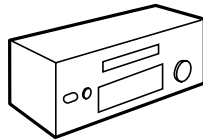

Connect as digital audio for data recorded as MD, CD-R or DAT.

- Connect the player's coaxial digital output jacks to a MD player, CD-R player, or DAT player.
- Connect the unit's digital output PCM/  jack to the digital audio recorder.

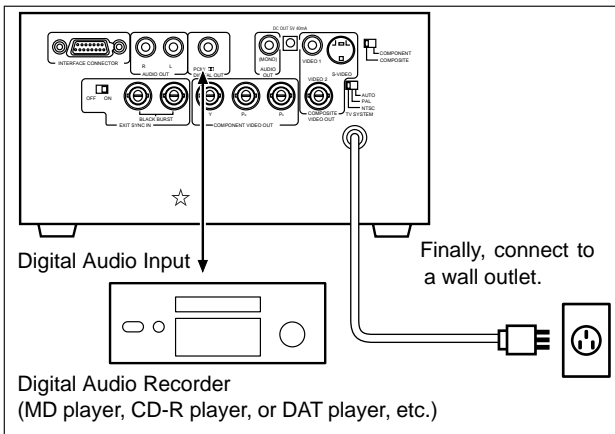

NOTE

When you record the Dolby Digital DVD, set [Digital Output] (see page 34) to [Dolby Digital▶PCM]. If [Digital Output] is set to [Dolby Digital] during recording Dolby Digital DVD, noise is recorded.

☆ Cables can be found at your local audio/video dealer.

Using a Laser Barcode Scanner (sold separately)

Laser Barcode Scanner

To use an optional LaserBarcode Scanner (UC-V108BC or UC-V109BC) in the wired mode to transmit signals, connect the LaserBarcode scanner's connection cord to the player's front-panel EXT.CONT jack.

To transmit barcode signals in the wireless mode, aim the remote control towards the player's signal receiver. Consult the LaserBarcode Scanner's Operating Instructions for operation details.

Note:

- During operations using the LaserBarcode Scanner, sending commands from a computer may cause malfunctions. This includes sending commands through the remote control, the front panel and serial signals. When using the LaserBarcode Scanner in the wired mode, the remote control is disabled in order to prevent erroneous commands from being sent. Thus, Pioneer recommends using the wired mode.
- When the player is operated via barcodes, some on-screen displays Play and Stop are hidden. (refer to the DVD-V7400 Command Protocol manual for details)
- Barcode commands issued for LD and DVD are ignored when a CD or CD Video disc is loaded.
- When a DVD is loaded, commands issued for CDs are ignored.

When used in wireless mode:

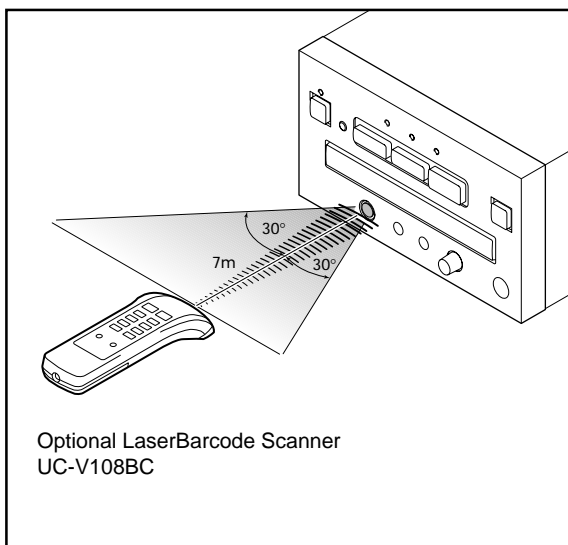

When used in wired mode:

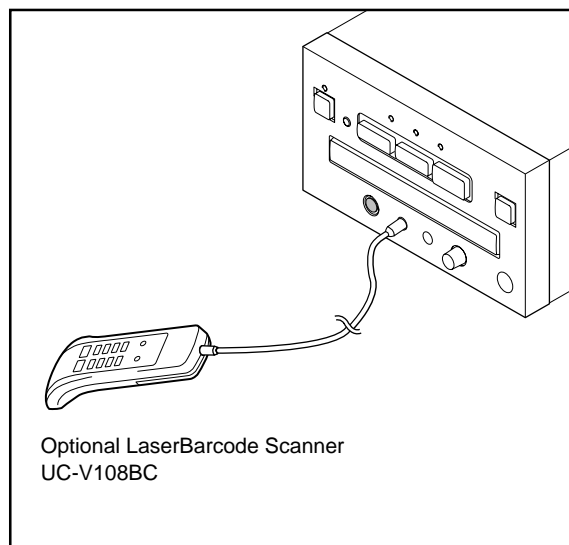

Troubleshooting

Please refer to the DVD-V7400 manuals for error code information before seeking support. Generally, device failures can be traced to many factors. Check the TV, monitor, AV amplifier, and speakers for compliance.

If the situation continues, contact your service personnel, the store where the player was purchased, or the nearest PIONEER Authorized Service Center.

Power fails to turn ON

- ➔ Check the power connections (pgs 80 - 83)

The disc table refuses to stay closed

- ➔ Set the disc in the disc table properly (pg 10)
- ➔ Clean the disc (pg 6)
- ➔ Check the region numbers (pgs 7 & 86)

The screen does not appear

- ➔ Check the setting of the Video Output selector on the back of the player with the connected video terminal (pgs 80 - 81)
- ➔ Check the cable connections (pgs 78 - 83)
- ➔ Match the television or AV amplifier setting to the DVD playback setting

Disc fails to play back

- ➔ Clean the disc (pg 6)
- ➔ Set the disc in the disc table properly (pg 10)
- ➔ Remove any condensation in the player (pg 6)
- ➔ SECAM format discs are incompatible
- ➔ Insert the disc with the proper side up

The newly-programmed settings disappear

- ➔ When the power has been turned OFF due to a power outage or because the power cord was pulled out of the socket while the power was ON, the settings are erased. Verify that the player is OFF and that the power indicator is orange before pulling the plug.

The screen stops and the operation buttons are not accepted

- ➔ After pressing  (STOP), play back once more

The mark appears on the screen

- ➔ The disc prohibits a particular command (pg 7)

The mark appears on the screen

- ➔ The player prohibits the operation (pg 7)

The remote control fails to send a command

- ➔ Verify that the remote control is used within the proper range (pg 10)
- ➔ Replace the batteries in the remote control (pg 3)

External synchronizing fails to perform

- ➔ Refer to the EXTERNAL SYNC setting in the ADV. SETUP menu. (pg 42)
- ➔ Check the NOTE for the external synchronizing function (pg 77)

No sound comes from the speakers or the sound is distorted

- ➔ Confirm that the audio cable is properly connected (pgs 78 - 83)
- ➔ Some discs prohibit 96 kHz digital output of Linear PCM audio. With this type of disc, even if the [96 kHz PCM Out] setting of Audio 1 on the Setup menu screen is set to [96 kHz], it changes automatically to 48 kHz (pg 35)
- ➔ During playback of a DVD recorded at 96 kHz in 16:9, if the [4:3 (Letter Box) - Video] is selected and the Audio 1 is set to [96 kHz PCM Out], it still changes automatically to 48 kHz (pg 23)
- ➔ Clean the disc (pg 6)
- ➔ If it has been set to the pause or slow playback mode, change to the playback mode (pg 15)
- ➔ If the volume of the television or AV amplifier, etc., is set to "minimum", raise the volume
- ➔ Confirm that the connector plug is in place and properly seated
- ➔ Check for dirt or grime on the connector plug or terminals

The screen extends vertically or horizontally to stretch the picture

- ➔ Adjust the TV Screen setting (pg 24)

The volumes are different between the DVD and CD discs

- ➔ This is due to the difference in the disc recording methods

The picture is distorted or dark when playing a DVD disc

- ➔ This player has the copy guard of an analog copy protect system. Some discs have a copy prohibition signal. When this type of disc is played back, lateral stripes may appear on part of the screen but this is not a defect or error.

The picture distorts when video on a DVD disc is recorded then played on a VCR

- ➔ This player has the copy guard of an analog copy protect system. Some discs have a copy prohibition signal. When this type of disc plays on a VCR, and is recorded then played back on a VCR, the quality is lowered because of the copy guard technology.

The television or other device malfunctions

- ➔ Some televisions with a wireless remote control malfunction because of conflicts with the player's remote control.

When the Setup menu appears, a screen set to Letter Box suddenly becomes vertically extended

- ➔ When the Setup menu appears while the picture is set to Letter Box or Pan & Scan mode, the screen size is forcibly changed to the wide-screen mode. This is a feature of the player (pg 24).

Outside influences such as static electricity may cause errors or playback issues. The player may return to normal operation after the power cord has been temporarily unplugged then plugged in again. If the problem still exists, consult the store where the unit was purchased or with an authorized service center.

Terms

Aspect

Aspect Ratio refers to the length to height ratio of a TV screen. The ratio of a normal TV is 4:3, while the ratio of a Hi-Vision or Wide TV is 16:9. This allows you to enjoy a picture with a wider perspective.

Component Video Output

The color signal of the TV is divided into the luminance (Y) signal and the two color (P_B and P_R) signals before output. This method avoids interference between the signals. On a TV with component input jacks, these signals are synthesized to produce a picture.

Parental Level

Parental level controls are restrictions incorporated into scenes that limit content viewing.

Dynamic Range

Dynamic range refers to the difference between the maximum and minimum levels of the audio soundtrack as measured in decibels (dB).

Dolby Digital

The maximum 5.1 channels of audio used in the surround system (Surround Digital) for movie theaters is digital data compressed by AC-3.



For DVD discs, the digital output PCM/  jack must be connected to the amplifier or processor's digital input AC-3/PCM jack.

Playback Control (PBC)

This refers to signals recorded on a Video CD (Version 2.0) enabling playback control.

Use menus recorded on discs with PBC for easy, interactive searching for desired scenes and playback. Also enjoy the high-resolution and standard resolution still images.

Multi-Angle

This feature refers to a sequence recorded from different viewpoints. Some DVD discs include an additional view or up to nine views or angles. The number of angles rely upon the producer's or director's discretion.

Multi-Audio

Some DVD has multi audio language streams. Up to eight separate streams may be recorded on a DVD disc. These can include language options or sound effects.

Subtitle

Subtitles are language titles super-imposed over movies etc. Up to 32 subtitle languages can be recorded on a DVD disc. The subtitle function can be used to select any language from a particular disc.

Regional Restriction Codes (Region Number)

Regional restriction codes are built in to DVD players and DVD discs for each global region. If the regional restriction codes of the player does not match one of the regional codes of the DVD disc, playback fails.

The regional restriction code can be found on the rear panel of the DVD player.

Linear PCM

This refers to a DVD audio recording format which matches the format for CD audio. However, the sampling frequency is recorded at 48 kHz and 96 kHz, with audio at an improved sound quality than that of CD.

DTS

DTS stand for Digital Theater System. DTS is a surround sound system different from Dolby Digital but is a popular format for movies.



MPEG

MPEG stand for Moving Picture Expert Group that is an international standard for compression of moving images. Some DVDs have the digital audio compressed and recorded in this format.

PCM

PCM stands for Pulse Code Modulation and is digital audio signal. The digital audio of CD and DVD discs is PCM.

5.1 ch

This refers to multi-channel audio with a special low sound range (0.1 channel) added to the five channels of front left/right, center and rear left/right. Dolby Digital and DTS surround systems use this configuration.

Specifications

General

System DVD system , Compact Disc digital video and Compact Disc digital audio system
 Power requirements AC 120 V, 50/60 Hz
 Power consumption 16 W
 Power consumption in standby mode 0.5W
 Weight 4.7 kg (10.6 lb)
 Dimensions 210 (W) x 408 (D) x 119 (H) mm
 (8 1/4 x 16 1/8 x 4 11/16 in.)
 (Not including protruding cables, etc.)
 Operating temperature +5°C to +35°C (+41°F to +95°F)
 Operating humidity No more than 85% (no condensation)

Video Output

Output level 1 Vp-p
 (75Ω when loaded, synchronous negative)
 Jacks BNC, RCA

S-Video Output

Y (luminance) - Output level 1 Vp-p (75Ω)
 C (color) - Output level 286 mVp-p (75Ω)

Component video Output

Y - Output level 1 Vp-p (75Ω) BNC
 P_B - Output level 0.7 Vp-p (75Ω) BNC
 P_R - Output level 0.7 Vp-p (75Ω) BNC
 S/N ratio more than 60 dB
 Horizontal resolution more than 500

External synchronizing input

Input signal level Black burst
 0.3 Vp-p (75Ω) BNC x 2 (loop through)

Audio Output

Output level
 During audio output 200 mVrms (1 kHz, -20 dB)
 Number of channels 2
 Frequency response 4 Hz to 22 kHz (DVD fs: 48 kHz)
 4 Hz to 20 kHz (CD)
 S/N ratio 115 dB (EIAJ)
 Dynamic range 98 dB (EIAJ)
 Wow and flutter ±0.001% W. PEAK or lower (EIAJ)

Other Terminals

Coaxial digital output (PCM/ DD) RCA jack
 Communication interface (RS-232C) D-SUB, 15-pin

Accessories

Audio cord 1
 Video cord 1
 Remote control unit 1
 AA (R6P) dry cell batteries 2
 Laser barcode Sheet 1
 RF adaptor set clamp 1
 Screw 1
 Operating Instructions 1
 Warranty card 1

NOTES:

- All values listed in these specifications are standard values.
- The specifications and product design are subject to change without notice.



Dear Customer:

Selecting fine audio equipment such as the unit you've just purchased is only the start of your musical enjoyment. Now it's time to consider how you can maximize the fun and excitement your equipment offers. This manufacturer and the Electronic Industries Association's Consumer Electronics Group want you to get the most out of your equipment by playing it at a safe level. One that lets the sound come through loud and clear without annoying blaring or distortion-and, most importantly, without affecting your sensitive hearing.

Sound can be deceiving. Over time your hearing "comfort level" adapts to higher volumes of sound. So what sounds "normal" can actually be loud and harmful to your hearing. Guard against this by setting your equipment at a safe level BEFORE your hearing adapts.

To establish a safe level:

- Start your volume control at a low setting.
- Slowly increase the sound until you can hear it comfortably and clearly, and without distortion.

Once you have established a comfortable sound level:

- Set the dial and leave it there.

Taking a minute to do this now will help to prevent hearing damage or loss in the future. After all, we want you listening for a lifetime.

We Want You Listening For A Lifetime

Used wisely, your new sound equipment will provide a lifetime of fun and enjoyment. Since hearing damage from loud noise is often undetectable until it is too late, this manufacturer and the Electronic Industries Association's Consumer Electronics Group recommend you avoid prolonged exposure to excessive noise. This list of sound levels is included for your protection.

Decibel

Level Example

30	Quiet library, soft whispers
40	Living room, refrigerator, bedroom away from traffic
50	Light traffic, normal conversation, quiet office
60	Air conditioner at 20 feet, sewing machine
70	Vacuum cleaner, hair dryer, noisy restaurant
80	Average city traffic, garbage disposals, alarm clock at two feet.

THE FOLLOWING NOISES CAN BE DANGEROUS UNDER CONSTANT EXPOSURE

90	Subway, motorcycle, truck traffic, lawn mower
100	Garbage truck, chain saw, pneumatic drill
120	Rock band concert in front of speakers, thunderclap
140	Gunshot blast, jet plane
180	Rocket launching pad

Information courtesy of the Deafness Research Foundation.



Should this product require service in the U.S.A. and you wish to locate the nearest Pioneer Authorized Independent Service Company, or if you wish to purchase replacement parts, operating instructions, service manuals, or accessories, please call the number shown below.

8 0 0 - 4 2 1 - 1 4 0 4

Please do not ship your product to Pioneer without first calling the Customer Service Department at the above listed number for assistance.

PIONEER ELECTRONICS SERVICE, INC.
CUSTOMER SERVICE DEPARTMENT
P.O. BOX 1760, LONG BEACH,
CA 90801-1760, U.S.A.

For warranty information please see the Limited Warranty sheet included with your product.

Should this product require service in Canada, please contact a Pioneer Canadian Authorized Dealer to locate the nearest Pioneer Authorized Service Company in Canada.

Alternatively, please contact the Customer Service Department at the following address:

Pioneer Electronics of Canada, Inc.
Customer Service Department
300 Allstate Parkway, Markham, Ontario L3R OP2
(905) 479-4411
1-877-283-5901

For warranty information please see the Limited Warranty sheet included with your product.

Si ce produit doit être réparé au Canada, veuillez vous adresser à un distributeur autorisé Pioneer au Canada pour obtenir le nom de la Société de Service Autorisée Pioneer le plus près de chez vous. Ou encore, veuillez vous communiquer avec le Service de Clientèle de Pioneer:

Pioneer électroniques du Canada, Inc.
Département de service au consommateurs
300 Allstate Parkway, Markham, Ontario L3R OP2
(905) 479-4411
1-877-283-5901

Pour obtenir des renseignements sur la garantie, veuillez vous reporter au feuillet sur la Garantie Limitée qui accompagne le produit.

Information about this product

<http://www.pioneerusa.co.jp>

Published by Pioneer Corporation.
Copyright © 1999 Pioneer Corporation.
All rights reserved.

PIONEER CORPORATION 4-1, Meguro 1-Chome, Meguro-ku, Tokyo 153-8654, Japan

PIONEER NEW MEDIA TECHNOLOGIES, INC.

2265 East 220th Street, Long Beach, CA 90810, U.S.A. TEL:1-310-952-2111

PIONEER ELECTRONICS [USA] INC. P.O. BOX 1540, Long Beach, California 90801-1540

PIONEER ELECTRONICS OF CANADA, INC. 300 Allstate Parkway, Markham, Ontario L3R OP2, Canada

PIONEER ELECTRONIC [EUROPE] N.V.

Multimedia Division: PIONEER House, Hollybush Hill STOKE POGES, SLOUGH SL2 4QP UK TEL: 44-1-753-789-789 FAX: 44-1-753-789-880

PIONEER ELECTRONICS AUSTRALIA PTY. LTD. 178-184 Boundary Road, Braeside, Victoria 3195, Australia, TEL: 61-39-586-6300

PIONEER ELECTRONICS DE MEXICO S.A. DE C.V. San Lorenzo Num 1009 3er piso Desp. 302 Col. Del Valle, Mexico D.F. C.P. 03100
TEL: 52-5-688-52-90